

Thank you for your selection of the WI-I/O-9-x WI-I/O-EX-1-S-x module for your I/O needs. We trust it will give you many years of valuable service.

ATTENTION!

Incorrect termination of supply wires may cause internal damage and will void warranty.

To ensure this product enjoys a long life,
**double check ALL your connections with
the user's manual**
before turning the power on.

Caution! For continued protection against risk of fire, replace the module fuse F1 only with the same type and rating.

CAUTION:

To comply with FCC RF Exposure requirements in section 1.1310 of the FCC Rules, antennas used with this device must be installed to **provide a separation distance of at least 33 cm from all persons** to satisfy RF exposure compliance.

DO NOT:

- operate the transmitter when someone is within 33 cm of the antenna
- operate the transmitter unless all RF connectors are secure and any open connectors are properly terminated.
- operate the equipment near electrical blasting caps or in an explosive atmosphere

All equipment must be properly grounded for safe operations. All equipment should be serviced only by a qualified technician.

FCC Notice: WI-I/O 9-x Wireless I/O Module

This user's manual is for the Weidmuller, Inc. WI-I/O 9-x wireless I/O module. This device complies with Part 15.247 of the FCC Rules.

Operation is subject to the following two conditions:

- 1) This device may not cause harmful interference and
- 2) This device must accept any interference received, including interference that may cause undesired operation.

This device must be operated as supplied by Weidmuller, Inc. Any changes or modifications made to the device without the written consent of Weidmuller, Inc. Technologies may void the user's authority to operate the device.

End user products that have this device embedded must be installed by experienced radio and antenna personnel, or supplied with non-standard antenna connectors, and antennas available from vendors specified by Weidmuller, Inc. Please contact Weidmuller, Inc. Technologies for end user antenna and connector recommendations.

Notices: Safety

Exposure to RF energy is an important safety consideration. The FCC has adopted a safety standard for human exposure to radio frequency electromagnetic energy emitted by FCC regulated equipment as a result of its actions in Docket 93-62 and OET Bulletin 65 Edition 97-01.

FCC Notice: WI-I/O-EX-1-S-x Wireless I/O Module

Part 15 – This device has been tested and found to comply with the limits for a Class B digital device, pursuant to Part 15 of the FCC rules (Code of Federal Regulations 47CFR Part 15). Operation is subject to the condition that this device does not cause harmful interference.

Part 90 – This device has been type accepted for operation by the FCC in accordance with Part 90 of the FCC rules (47CFR Part 90). See the label on the unit for the specific FCC ID and any other certification designations.

Industry Canada: WI-I/O-EX-1-S-x Wireless I/O Module

RSS-119 - This device has been type accepted for operation by Industry Canada in accordance with RSS-119 of the Industry Canada rules. See the label on the unit for the specific Industry Canada certification number and any other certification designations.

Notice Any changes or modifications not expressly approved by Weidmuller, Inc. could void the user's authority to operate this equipment.

To operate this equipment legally the user must obtain a radio operating license from the government agency. This is done so the government can coordinate radio users in order to minimize interference.

Important Notice

Weidmuller, Inc. products are designed to be used in industrial environments, by experienced industrial engineering personnel with adequate knowledge of safety design considerations.

Weidmuller, Inc. radio products are used on unprotected license-free radio bands with radio noise and interference. The products are designed to operate in the presence of noise and interference, however in an extreme case, radio noise and interference could cause product operation delays or operation failure. Like all industrial electronic products, Weidmuller, Inc. products can fail in a variety of modes due to misuse, age, or malfunction. We recommend that users and designers design systems using design techniques intended to prevent personal injury or damage during product operation, and provide failure tolerant systems to prevent personal injury or damage in the event of product failure. Designers must warn users of the equipment or systems if adequate protection against failure has not been included in the system design. Designers must include this Important Notice in operating procedures and system manuals.

These products should not be used in non-industrial applications, or life-support systems, without consulting Weidmuller, Inc. first.

1. For WI-I/O 9-x modules, a radio licence is not required in many countries, provided the module is installed using the antenna and equipment configuration complying with the country's regulations.. Check with your local distributor for further information on regulations.
2. For WI-I/O 9-x modules, operation is authorised by the radio frequency regulatory authority in your country on a non-protection basis. Although all care is taken in the design of these units, there is no responsibility taken for sources of external interference. The WI-I/O 9-x intelligent communications protocol aims to correct communication errors due to interference and to retransmit the required output conditions regularly. However some delay in the operation of outputs may occur during periods of interference. Systems should be designed to be tolerant of these delays.
3. To avoid the risk of electrocution, the antenna, antenna cable, serial cables and all terminals of the WI-I/O 9-x_WI-I/O-EX-1-S-x module should be electrically protected. To provide maximum surge and lightning protection, the module should be connected to a suitable earth and the antenna, antenna cable, serial cables and the module should be installed as recommended in the Installation Guide.
4. To avoid accidents during maintenance or adjustment of remotely controlled equipment, all equipment should be first disconnected from the WI-I/O 9-x_WI-I/O-EX-1-S-x module during these adjustments. Equipment should carry clear markings to indicate remote or automatic operation. E.g. "This equipment is remotely controlled and may start without warning. Isolate at the switchboard before attempting adjustments."
5. The WI-I/O 9-x_WI-I/O-EX-1-S-x module is not suitable for use in explosive environments without additional protection. These modules are approved for use in Class 1 Division 2 areas in North America.

Limited Lifetime Warranty, Disclaimer and Limitation of Remedies

Weidmuller, Inc. products are warranted to be free from manufacturing defects for the “serviceable lifetime” of the product. The “serviceable lifetime” is limited to the availability of electronic components. If the serviceable life is reached in less than three years following the original purchase from Weidmuller, Inc., Weidmuller, Inc. will replace the product with an equivalent product if an equivalent product is available.

This warranty does not extend to:

- failures caused by the operation of the equipment outside the particular product's specification, or
- use of the module not in accordance with this User Manual, or
- abuse, misuse, neglect or damage by external causes, or
- repairs, alterations, or modifications undertaken other than by an authorized Service Agent.

Weidmuller, Inc.’s liability under this warranty is limited to the replacement or repair of the product. This warranty is in lieu of and exclusive of all other warranties. This warranty does not indemnify the purchaser of products for any consequential claim for damages or loss of operations or profits and Weidmuller, Inc. is not liable for any consequential damages or loss of operations or profits resulting from the use of these products. Weidmuller, Inc. is not liable for damages, losses, costs, injury or harm incurred as a consequence of any representations, warranties or conditions made by Weidmuller, Inc. or its representatives or by any other party, except as expressed solely in this document..

How to Use This Manual

To receive the maximum benefit from your WI-I/O 9-x_WI-I/O-EX-1-S-x product, please read the **Introduction, Installation** and **Operation** chapters of this manual thoroughly before putting the product to work.

Chapter Four **Configuration** explains how to configure the modules using the Configuration Software available.

Chapter Five **Specifications** details the features of the product and lists the standards to which the product is approved.

Chapter Six **Troubleshooting** will help if your system has problems and Chapter Seven specifies the **Warranty and Service** conditions.

The foldout sheet *Installation Guide* is an installation drawing appropriate for most applications.

CONTENTS

CHAPTER ONE INTRODUCTION	8
1.1 GENERAL	8
CHAPTER TWO INSTALLATION.....	11
2.1 GENERAL	11
2.2 ANTENNA INSTALLATION (WI-I/O 9-x & WI-I/O-EX-1-S-x UNITS ONLY).....	11
2.2.1 Dipole and Collinear antennas	13
2.2.2 Yagi antennas	13
2.3 POWER SUPPLY	15
2.3.1 AC Supply.....	15
2.3.2 DC Supply.....	15
2.3.3 Solar Supply.....	16
2.3.4 Multiple Modules.....	17
2.3.5 24V Regulated Supply	18
2.4 INPUT / OUTPUT	18
2.4.1 Digital Inputs (WI-I/O 9-1, WI-I/O 9-2 and WI-I/O 9-4)	18
2.4.2 Digital Outputs (WI-I/O 9-1)	18
2.4.3 Digital Outputs (WI-I/O 9-2, WI-I/O 9-3 and WI-I/O 9-4).....	19
2.4.4 Analog Inputs (WI-I/O 9-1 and WI-I/O 9-2).....	19
2.4.5 Analog Outputs (WI-I/O 9-1 and WI-I/O 9-3).....	20
2.4.6 Pulse Input (WI-I/O 9-1).....	23
2.4.7 Pulse Inputs (WI-I/O 9-2 and WI-I/O 9-4).....	23
2.4.8 Pulse Output (WI-I/O 9-1)	24
2.4.9 Pulse Output (WI-I/O 9-3 and WI-I/O 9-4).....	24
2.4.10 RS232 Serial Port.....	25
2.4.11 RS485 Serial Port.....	25
2.4.12 Connecting WI-I/O-EX-1-S-x Modules to WI-I/O 9-x Modules.....	26
CHAPTER THREE OPERATION.....	27
3.1 POWER-UP AND NORMAL OPERATION.....	27
3.1.1 Communications	27
3.1.2 Change of state conditions	29
3.1.3 Analog Set-points.....	32
3.1.4 Start-up Poll	32
3.1.5 Communications Failure (CF)	32
3.1.6 Resetting Outputs.....	33
3.2 SYSTEM DESIGN TIPS	33
3.2.1 System Dynamics.....	33
3.2.2 Radio Channel Capacity.....	33
3.2.3 Radio Path Reliability	34
3.2.4 Design for Failures.....	34
3.2.5 Indicating a Communications Problem.....	35

3.2.6	Testing and Commissioning.....	36
3.3	SECURITY CONSIDERATIONS	36
CHAPTER FOUR	CONFIGURATION.....	38
4.1	INTRODUCTION.....	38
4.2	EASY CONFIGURATION USING DEFAULT SETTINGS	39
4.3	CONFIGURATION SOFTWARE	41
4.3.1	Hardware and Software Requirements.....	41
4.3.2	Program Operation	41
4.3.4	Loading Configuration from a Module	52
4.3.5	Modifying and Archiving Configuration Files.....	53
4.3.6	Print Options	53
4.3.7	Security	53
4.3.8	Using WI-I/O-EX-1-S-x Modules.....	55
CHAPTER FIVE	SPECIFICATIONS.....	58
5.1	DIMENSIONED DRAWING.....	ERROR! BOOKMARK NOT DEFINED.
CHAPTER SIX	TROUBLESHOOTING	ERROR! BOOKMARK NOT DEFINED.
6.1	DIAGNOSTICS CHART	ERROR! BOOKMARK NOT DEFINED.
6.2	SELF TEST FUNCTIONS	63
6.2.1	Input to Output Reflection (WI-I/O 9-1_WI-I/O-EX-1-S-x-1 only)	63
6.2.2	Radio Testing using Tone Reversals (WI-I/O 9-x modules only).....	63
6.2.3	Diagnostics menu.....	63
6.2.4	Comms Logging.....	69
6.3	RADIO PATH TESTING	71
CHAPTER SEVEN	WARRANTY & SERVICE.....	73
APPENDIX A	SYSTEM EXAMPLE.....	74
APPENDIX B	TERMINAL LAYOUTS	80

Chapter One

INTRODUCTION

1.1

General

The WI-I/O 9-x & WI-I/O-EX-1-S-x range of I/O modules has been designed to provide standard “off-the-shelf” telemetry functions, for an economical price. *Telemetry* is the transmission of signals over a long distance via a medium such as radio or twisted-pair wire. Although the WI-I/O 9-x_WI-I/O-EX-1-S-x is intended to be simple in its application, it also provides many sophisticated features. This manual should be read carefully to ensure that the modules are configured and installed to give reliable performance.

The unit can monitor and control the following types of signals:

Digital on/off signals

Example outputs - motor run, siren on

Example inputs - motor fault, tank overflow, intruder alarm

Analog continuously variable signals (0-20mA)

Example outputs - tank level indication, required motor speed

Example inputs - measured tank level, actual motor speed

Pulse frequency signals

Examples - electricity metering, fluid flow

Internal Status signals

Examples - analog battery voltage, power status, solar panel status and low battery status.

The unit will monitor the input signals and transmit the signal information by radio or RS485 twisted pair to another module or modules. At the remote unit, the signals will be reproduced as digital, analog or pulse output signals. The modules also provide analog set points, so that a digital output may be configured to turn on and off depending on the value of an analog input. The pulse I/O transmits an accumulated value and the pulses are reliably recreated at the remote unit regardless of ‘missed’ transmissions. The actual pulse rate is also calculated and is available as a remote analog output.

This manual covers the WI-I/O 9-x and WI-I/O-EX-1-S-x modules. We have provided a summary on all products available in the range, below.

- **WI-I/O 9-1, WI-I/O 9-2, WI-I/O 9-3 and WI-I/O 9-4** modules have radio **and** serial communications. The modules differ only in their input/output (I/O) design, and are compatible, i.e. they can be used to communicate signals to each other in the same network. The WI-I/O 9-x has a frequency hopping spread spectrum 900MHz radio which is license-free in many countries.

•

- **WI-I/O-EX-1-S-1, WI-I/O-EX-1-S-2, WI-I/O-EX-1-S-3 and WI-I/O-EX-1-S-4** modules have **only** serial communications. All other specifications are as per the WI-I/O 9-1, 2, 3 & 4 modules. The WI-I/O-EX-1-S-x modules are compatible with WI-I/O 9-x modules. WI-I/O-EX-1-S-x modules may be used for serial I/O applications, or as I/O expansion for WI-I/O 9-x modules.
- The **WI-GTWY-9-xxx** modules provides an interface between host devices such as PLC's or SCADA computers, and a wireless I/O system comprising WI-I/O 9-x modules. The WI-GTWY-9-xxx allows WI-I/O 9-x modules to act as remote wireless I/O for the host devices. For more information, refer to the **WI-GTWY-9-xxx User Manual**.

The WI-I/O 9-x radio has been designed to meet the requirements of unlicensed operation for remote monitoring and control of equipment. That is, a radio licence is not required for the WI-I/O 9-x modules in many countries. See Chapter Five **Specifications** for details. A radio license is not required to use the WI-I/O 9-x products.

I/O Types

	WI-I/O 9-1	WI-I/O-EX-1-S-11	WI-I/O 9-2	WI-I/O-EX-1-S-12	WI-I/O 9-3	WI-I/O-EX-1-S-13	WI-I/O 9-4
Radio	✓		✓		✓		✓
Serial	✓	✓	✓	✓	✓	✓	
Digital Inputs (DI)	4	Up to 16	4	8 voltage-free contacts		Up to 8	4 to 16
Digital Outputs (DO)	4 (relay)	Up to 16	1 (FET)	Up to 8 (FET)	8 (FET)	Up to 8	4 to 16 (FET)
Analog Inputs (AI)	2 (4-20mA)		6 (0-20mA)	4 floating 8 commoned			
Analog Outputs (AO)	2 (4-20mA)				8 (0-20mA)	8 sink source	
Pulse Inputs (PI)	1 (100Hz)	4 (1KHz)	4 (1x1KHz, 3x100Hz)				4 (1x1KHz, 3x100Hz)
Pulse Outputs (PO)	1 (100Hz)	8 (15Hz)		8 (15Hz)	4 (100 Hz)	8 (15Hz)	4 (100 Hz)
Comments	PI is DI 1. PO is separate to DO.		PI's are the same as DI's.		PO's are the same as DO's .		PI/ PO's are the same as DI/ DO's.

Note regarding -4 modules. The WI-I/O 9-x_WI-I/O-EX-1-S-4 has a total of 20 digital I/O. Four are fixed inputs (also PI's) and four are fixed outputs (also PO's). The other 12 are selectable individually as DI or DO. The I/O range can vary from 16DI + 4DO to 4DI + 16DO or any combination in between.

Input signals connected to a module are transmitted to another module and appear as output signals. These input signals may also be configured to appear as “inverted” signals on the output. A transmission occurs whenever a "change-of-state" occurs on an input signal. A "change-of-state" of a digital or digital internal input is a change from "off" to "on" or vice-versa. A "change-of-state" for an analog input, internal analog input or pulse input rate is a change in value of the signal of 3% (configurable from 0.8 to 75 %).

In addition to change-of-state messages, update messages are automatically transmitted on a regular basis. The time period may be configured by the user for each input. This update ensures the integrity of the system.

Pulse inputs are accumulated as a pulse count and the accumulated pulse count is transmitted regularly according to the configured update time.

The I/O modules transmit the input/output data as a data frame using radio or serial RS485 as the communications medium. The data frame includes the "address" of the transmitting module and the receiving module, so that each transmitted message is acted on only by the correct receiving unit. Each transmitted message also includes error checking to ensure that no corruption of the data frame has occurred due to noise or interference. The module with the correct receiving "address" will acknowledge the message with a return transmission. If the original module does not receive a correct acknowledgement to a transmission, it will retry up to five times before setting the communications fail status of that path. In critical paths, this status can be reflected on an output on the module for alert purposes. The module will continue to try to establish communications and retry, if required, each time an update or change-of-state occurs.

A system may be a complex network or a simple pair of modules. An easy-to-use configuration procedure allows the user to specify any output destination for each input.

The maximum number of modules in one system is 95 modules communicating by radio. Each of these modules may have up to 31 other modules connected by RS485 twisted pair. Modules may communicate by radio only, by RS485 only or by both RS485 and radio. Any input signal at any module may be configured to appear at any output on any module in the entire system.

Systems with a WI-GTWY-9-xxx module and host device can have more than 95 radio modules.

Modules can be used as repeaters to re-transmit messages on to the destination module. Repeaters can repeat messages on the radio channel, or from the radio channel to the serial channel (and serial to radio). Up to five repeater addresses may be configured for each input-to-output link.

The units may be configured by using a PC connected to the RS232 port. The default configuration and software configuration is defined in Section 4 **Configuration**.

2.1

General

The WI-I/O 9-x_WI-I/O-EX-1-S-x module is housed in a rugged aluminium case, suitable for DIN-rail mounting. Terminals are suitable for cables up to 2.5 sqmm in size.

All connections to the module should be SELV only. Normal 110/220/240V mains supply should not be connected to any input terminal of the module. Refer to Section 2.3 Power Supply.

Each module should be effectively Fed/grounded via a "GND" terminal on the module - this is to ensure that the surge protection circuits inside the module are effective. The earth/ground wire should be connected to the same earth/ground point as the enclosure "earth" and the antenna mast "earth".

Before installing a new system, it is preferable to bench test the complete system. Configuration common problem is poor communications on the radio channel or the serial channel. For radio modules, problems are caused by incorrectly installed antennas, or radio interference on the same channel, or the radio path being inadequate. If the radio path is a problem (i.e. path too long, or obstructions in the way), then higher performance antennas or a higher mounting point for the antenna may fix the problem. Alternately, use an intermediate module as a repeater.

For serial modules, poorly installed serial cable, or interference on the serial cable is a common problem.

The foldout sheet Installation Guide provides an installation drawing appropriate to most applications. Refer to Appendix B of this manual for terminal layout drawings of the modules.

2.2

Antenna Installation *(WI-I/O 9-x units only)*

The WI-I/O 9-x module will operate reliably over large distances. The distance which may be reliably achieved will vary with each application - depending on the type and location of antennas, the degree of radio interference, and obstructions (such as hills or trees) to the radio path. Typical reliable distances are :

USA/Canada 15 miles 6dB net gain antenna configuration permitted (4W ERP)

Australia/NZ 12 km unity gain antenna configuration (1W ERP)

Longer distances can be achieved if one antenna is mounted on top of a hill.

To achieve the maximum transmission distance, the antennas should be raised above intermediate obstructions so the radio path is true "line of sight". Because of the curvature of the earth, the antennas will need to be elevated at least 15 feet (5 metres) above ground for paths greater than 3 miles (5 km). The modules will operate reliably with some obstruction of the radio path, although the reliable distance will be reduced. Obstructions which are close to either antenna will have more of a blocking affect than obstructions in the middle of the radio path. For example, a group of trees around the antenna is a larger obstruction than a group of trees further away from the antenna. The WI-I/O 9-x modules provide a test feature which displays the radio signal strength.

Line-of-sight paths are only necessary to obtain the maximum range. Obstructions will reduce the range however, but may not prevent a reliable path. A larger amount of obstruction can be tolerated for shorter distances. For very short distances, it is possible to mount the antennas inside buildings. An obstructed path requires testing to determine if the path will be reliable (refer the section 6 of this manual).

Where it is not possible to achieve reliable communications between two modules, then a third module may be used to receive the message and re-transmit it. This module is referred to as a repeater. This module may also have input/output (I/O) signals connected to it and form part of the I/O network - refer to Chapter 4 **Configuration** of this manual.

An antenna should be connected to the module via 50 ohm coaxial cable (eg RG58, RG213 or Cellfoil) terminated with a male SMA coaxial connector. The higher the antenna is mounted, the greater the transmission range will be, however as the length of coaxial cable increases so do cable losses. For use on unlicensed frequency channels, there are several types of antennas suitable for use. It is important antenna are chosen carefully to avoid contravening the maximum power limit on the unlicensed channel (if in doubt refer to an authorised service provider).

The net gain of an antenna/cable configuration is the gain of the antenna (in dBi) less the loss in the coaxial cable (in dB).

The maximum net gain of the antenna/cable configuration permitted for WI-I/O 9-x is

Country	Max. gain (dB)
USA / Canada	6
Australia / New Zealand	0

The gains and losses of typical antennas for WI-I/O 9-x are

Standard Antennas	Gain (dB)	Part Numbers
Dipole with integral 15' cable	0	6720005080
5dBi Collinear(3dBd)	5	6720005081
8dBi Collinear (6dBd)	8	6720005082
6 element Yagi	10	6720005084
16 element Yagi	15	6720005085

Cable type	Loss (dB per 30 ft / 10 m)
RG58	-5
RG213	-2.5
Cellfoil	-3

The net gain of the antenna/cable configuration is determined by adding the antenna gain and the cable loss. For example, a 6 element Yagi with 70 feet (20 metres) of Cellfoil has a net gain of 4dB (10dB – 6dB).

Connections between the antenna and coaxial cable should be carefully taped to prevent ingress of moisture. Moisture ingress in the coaxial cable is a common cause for problems with radio systems, as it greatly increases the radio losses. We recommend that the connection be taped, firstly with a layer of PVC Tape, then with a vulcanising tape such as “3M 23 tape”, and finally with another layer of PVC UV Stabilised insulating tape. The first layer of tape allows the joint to be easily inspected when trouble shooting as the vulcanising seal can be easily removed.

Where antennas are mounted on elevated masts, the masts should be effectively earthed to avoid lightning surges. For high lightning risk areas, surge suppression devices between the module and the antenna are recommended. If the antenna is not already shielded from lightning strike by an adjacent earthed structure, a lightning rod may be installed above the antenna to provide shielding.

2.2.1 Dipole and Collinear antennas.

A collinear antenna transmits the same amount of radio power in all directions, making it easy to install and use. The dipole antenna with integral 15 feet cable does not require any additional coaxial cable, however a cable must be used with the collinear antenna.

Collinear and dipole antennas should be mounted vertically on a mast to obtain maximum range. The mast should be 1 metre away from a wall or other structure.

2.2.2 Yagi antennas.

A Yagi antenna provides high gain in the forward direction, but lower gain in other directions. This may be used to compensate for coaxial cable loss for installations with marginal radio path.

The Yagi gain also acts on the receiver, so adding Yagi antennas at both ends of a link provides a double improvement.

Yagi antennas are directional. That is, they have positive gain to the front of the antenna, but negative gain in other directions. Hence Yagi antennas should be installed with the central beam horizontal and must be pointed exactly in the direction of transmission to benefit from the gain of the antenna. The Yagi antennas may be installed with the elements in a vertical plane (vertically polarised) or in a

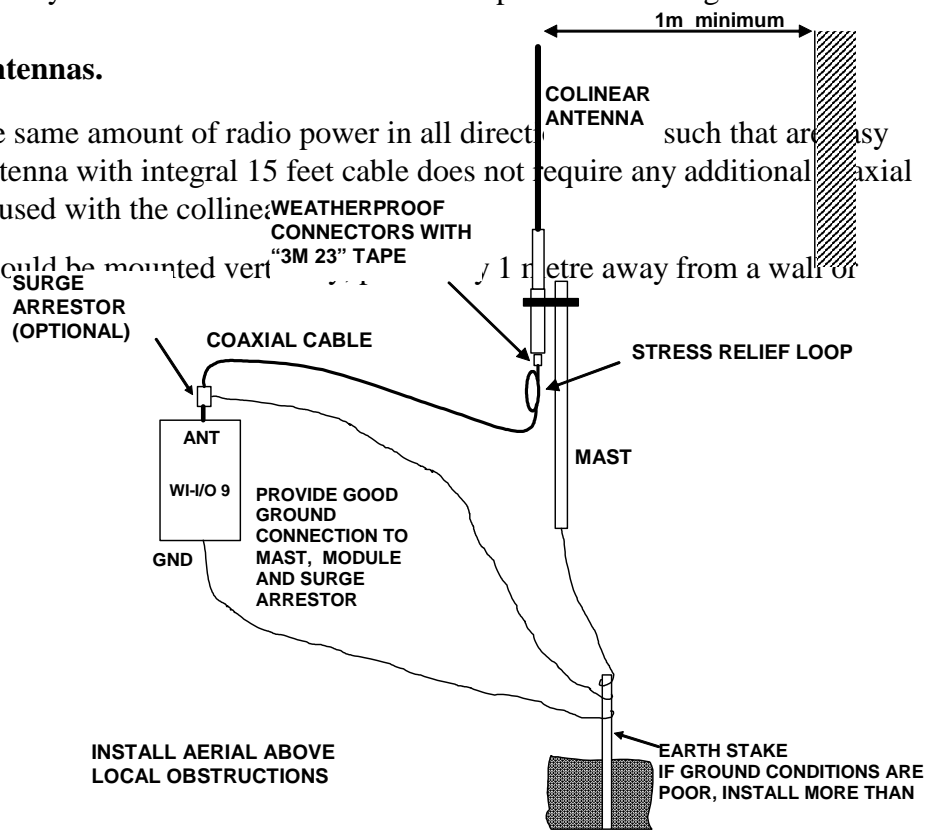

horizontal plane (horizontally polarised). For a two station installation, with both modules using Yagi antennas, horizontal polarisation is recommended. If there are more than two stations transmitting to a common station, then the Yagi antennas should have vertical polarisation, and the common (or “central” station) should have a collinear (non-directional) antenna.

Note that Yagi antennas normally have a drain hole on the folded element. The drain hole should be located on the bottom of the installed antenna.

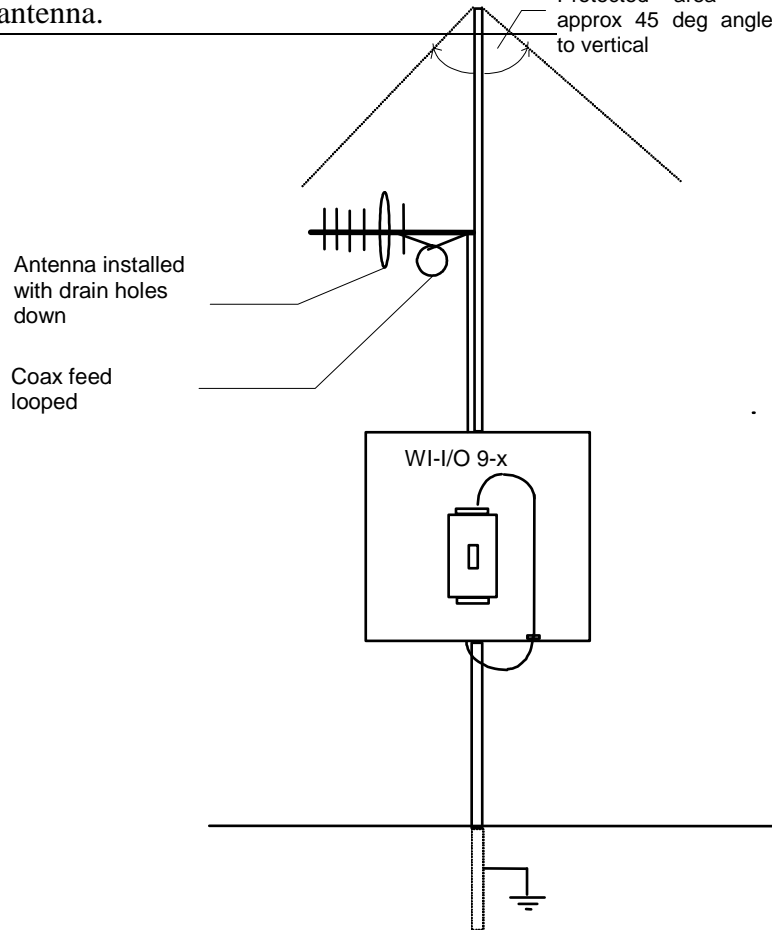

2.3

Power Supply

The WI-I/O 9-x_WI-I/O-EX-1-S-x power supply is a switch-mode design which will accept either AC or DC supply. The module may also be powered from a solar panel without an external solar regulator.

The module accepts supply voltages in the following ranges :

- 12 - 24 volts AC RMS or 15 - 30 volts DC at the “supply” terminals, or
- 11.5 -15 volts DC at the “battery” terminals.

The power supply should be rated at 1.5 Amps and be CSA Certified Class 2. For use in Class 1 Div 2 explosive areas, the power supply must be approved for Class 1 Div 2 use.

Note: Connect module to the same ground/earth point as the antenna mounting to avoid differences in earth potential during voltage surges. The modules need an earth connection for the internal surge protection to be effective.

2.3.1 AC Supply

The AC supply is connected to the "SUP1" and "SUP2" terminals as shown below.

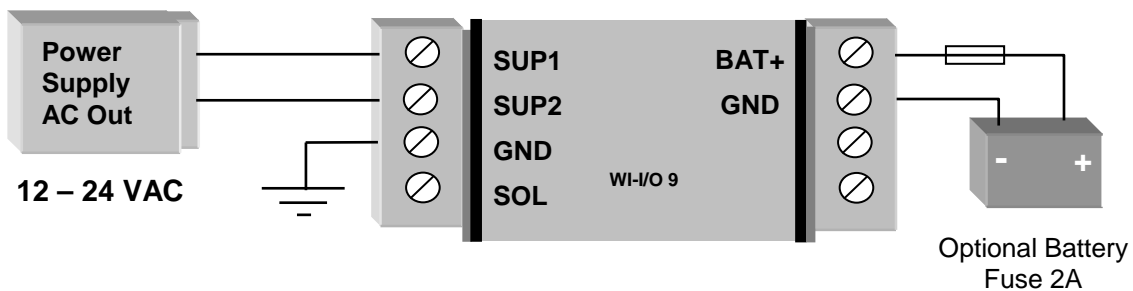

The AC supply should be "floating" relative to earth. AC transformers with grounded/earthed secondary windings should **not** be used.

2.3.2 DC Supply

For DC supplies, the positive lead is connected to "SUP1" and the negative to "GND". The positive side of the supply **must not be connected to earth**. The DC supply may be a floating supply or negatively grounded.

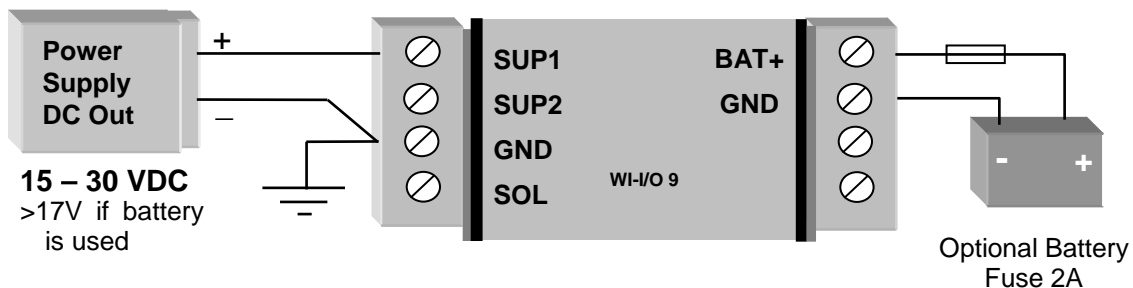

The module may also be powered from an external 11.5 - 15 VDC battery supply without the need for a "normal" supply connected to "SUP1". This external battery supply is connected to "BAT+" and "GND" terminals. The positive lead of the external supply should be protected by a 2A fuse.

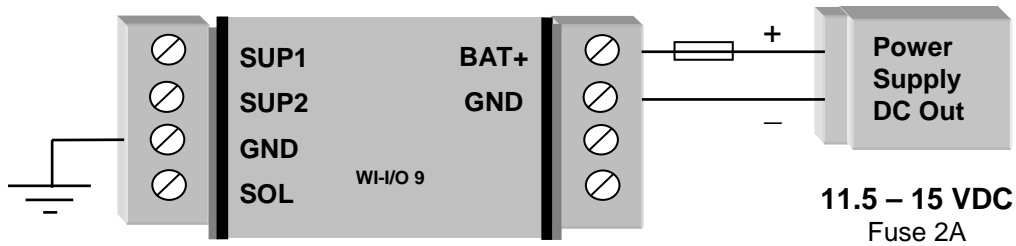

Upon failure of the normal supply, the module may continue to operate for several hours from a backup battery. The module includes battery charging circuits for charging up to a 12 AHr sealed lead acid battery. The battery is connected to the "BAT+" (positive) and "GND" (negative) terminals. The positive lead from the battery should be protected with a 2A fuse, installed as near to the battery terminal as possible. On return of main supply, the unit will switch back to mains operation, and recharge the battery. To provide adequate current to recharge the backup battery, an AC supply of 15V minimum or a DC supply of 17V minimum must be used. Typically, a 6 AHr battery will supply the WI-I/O 9-x for 1 - 3 days, depending on I/O loads.

2.3.3 Solar Supply

The power supply also includes a 12 V solar regulator for connecting 12V solar panels of up to 30W, and solar batteries of up to 100AHr. **The unit must not be powered from a solar panel without a battery.** A 20W solar panel is sufficient for most solar applications. The size of the solar battery required depends on the I/O used. Batteries are sized for a number of sunless days with 50% battery capacity remaining as follows:

$$\text{No. of sunless days} = \frac{\text{Battery capacity (AHr)} \times 0.5}{\text{Module load (A)} \times 1.2 \times 24}$$

The Module load depends on the I/O connected and can be calculated as follows:

$$\text{Module Load(mA)} = (85 \text{ for WI-I/O 9-x or } 45 \text{ for WI-I/O-EX-1-S-x}) + (10 \times \text{No. of active DI's}) + (25 \times \text{No. of active DO's}) + (2 \times \text{Analog loop load}).$$

The analog loop load is the total signal current for the AI's and AO's which are powered from the internal 24V supply. Externally powered loops are not included in this.

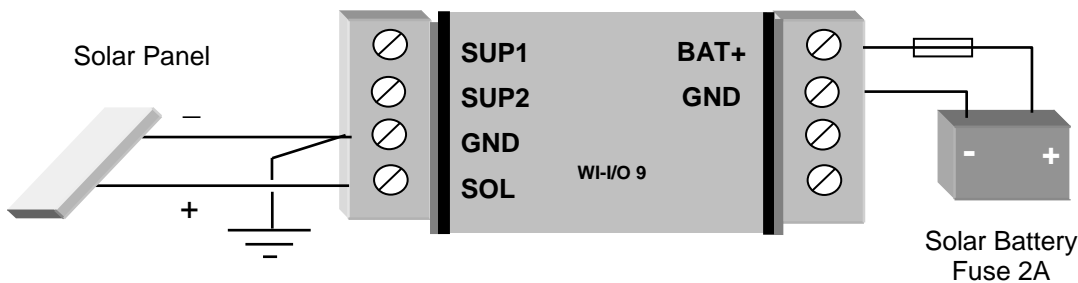

The solar panel is connected to the "SOL" (positive) and "GND" (negative) terminals and the battery connected to the "BAT+" (positive) and "GND" (negative) terminals. Solar panels must be installed and

connected as per the panel manufacturer's instructions. The positive lead of the battery should be protected by a 2A fuse installed as near as possible to the battery terminal.

Where a panel larger than 30W is required, an external solar regulator should be used.

For maintenance, disconnect the solar panel first before disconnecting the battery.

2.3.4 Multiple Modules

Where more than one module is installed at the one location, a shared power supply and battery may be used, provided the total load does not exceed the power supply.

The internal power supply of the module can supply a maximum 12V load of 700mA. In order to achieve this, the input power supply must be above 15VAC or 17VDC. Using these figures, it can be determined whether there is enough supply for more than one module - allow 100mA for recharging a battery.

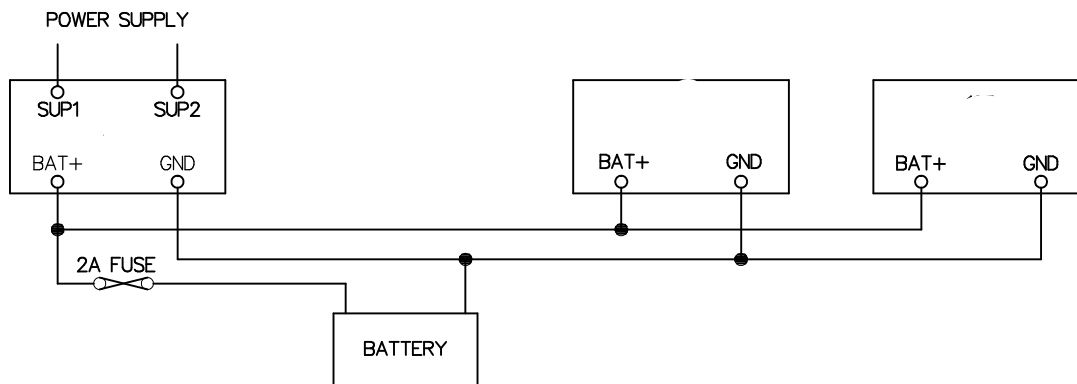

For example, assume there is a WI-I/O 9-1 module and a WI-I/O-EX-1-S-1 module at the same location. The total I/O at the location is 3 analog inputs, 6 digital inputs and 4 digital outputs. The total load will be :-

TYPE OF LOAD	LOAD mA
WI-I/O 9-1 quiescent	85
WI-I/O-EX-1-S-1 quiescent	45
6 DI @ 10 mA	60
3 AI @ 20mA x 2	120
4 DO @ 25mA	100
Battery charging	100
TOTAL	510

So both modules could be powered from one power supply and one battery, provided the external supply voltage is more than 15VAC or 17VDC.

2.3.5 24V Regulated Supply

Each module provides a 24V DC regulated supply for analog loop power, except for WI-I/O 9-4_WI-I/O-EX-1-S-4. The supply is rated at 150mA, and should **only** be used for powering analog loops.

2.4 Input / Output

2.4.1 Digital Inputs (WI-I/O 9-1, WI-I/O 9-2 and WI-I/O 9-4)

The "-1" and "-2" modules each provide four digital inputs with 5000 volt opto-isolation, and the "-4" provides 4 to 16 inputs with 3000 volt surge protection. All inputs are suitable for voltage free contacts (such as mechanical switches) or NPN transistor devices (such as electronic proximity switches). PNP transistor devices are not suitable. Contact wetting current of approximately 5mA is provided to maintain reliable operation of driving relays.

Each digital input is connected between the appropriate "DI" terminal and common "COM". Each digital input circuit includes a LED indicator which is lit when the digital input is active, that is, when the input circuit is closed. Provided the resistance of the switching device is less than 200 ohms, the device will be able to activate the digital input.

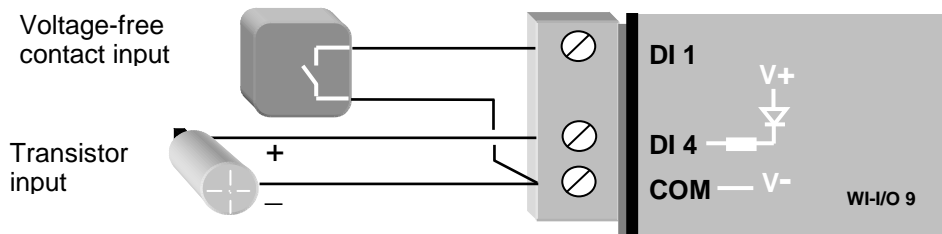

For pulse inputs, refer to Section 2.4.6.

2.4.2 Digital Outputs (WI-I/O 9-1)

The "-1" module provides four normally open voltage-free relay contacts, rated at AC 50V/5A, DC 30V/2A, 20V/5A. These outputs may be used to directly control low-powered equipment, or to power larger relays for higher powered equipment. When driving inductive loads such as AC relays, good installation should include capacitors (e.g. 10nf 250V) across the external circuit to prevent arcing across the relay contacts. For DC inductive loads, flyback diodes should be used across DC relays.

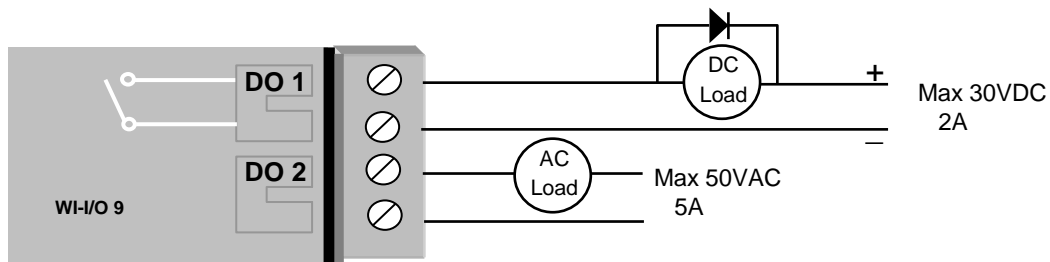

Digital outputs may be configured to individually turn off if no command message is received to that output for a certain period. This feature provides an intelligent watch dog for each output, so that a communications failure at a transmitting site causes the output to revert to a known state. See section 4.4 Changing User Options for further details.

The output circuit is connected to the appropriate pair of "DO" terminals. Each digital output circuit includes a LED indicator which is lit when the digital output is active.

2.4.3 Digital Outputs (WI-I/O 9-2, WI-I/O 9-3 and WI-I/O 9-4)

The digital outputs on the "-2", "-3" and "-4" modules are transistor switched DC signals, FET output to common rated at 30VDC 500 mA. The "-2" provides one digital output; the "-3" provides eight digital outputs and the "-4" provides 4 – 16 outputs. The first four DO's on the "-3" and "-4" modules are also the pulse outputs - that is, the first four DO's can be either digital outputs or pulse outputs. The function of each of these outputs may be configured individually. For a description of pulse outputs, refer to Section 2.4.7.

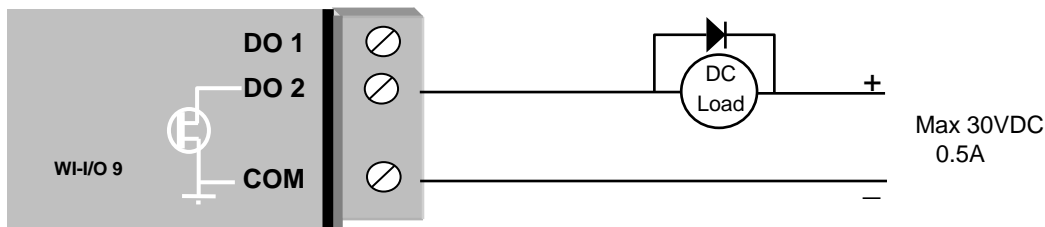

Digital outputs may be configured to individually turn off if no command message is received to that output for a certain period. This feature provides an intelligent watch dog for each output, so that a communications failure at a transmitting site causes the output to revert to a known state. See Chapter 4 Configuration for further details.

The output circuit is connected to the appropriate pair of "DO" terminals. Each digital output circuit includes a LED indicator which is lit when the digital output is active.

2.4.4 Analog Inputs (WI-I/O 9-1 and WI-I/O 9-2)

The "-1" module provides two 4 - 20 mA DC analog inputs for connecting to instrument transducers such as level, moisture, pressure transducers, etc. The "-2" module provides six 0 - 20 mA DC analog inputs. Note that the inputs on the "-2" module will measure down to 0mA, so they can also be used for zero based signals such as 0 - 10 mA. The modules transmit the "mA value" of the input, not a "% of range", so the output value is set to the correct mA signal.

Each analog input has a positive and negative terminal, and may be placed at any point in the current

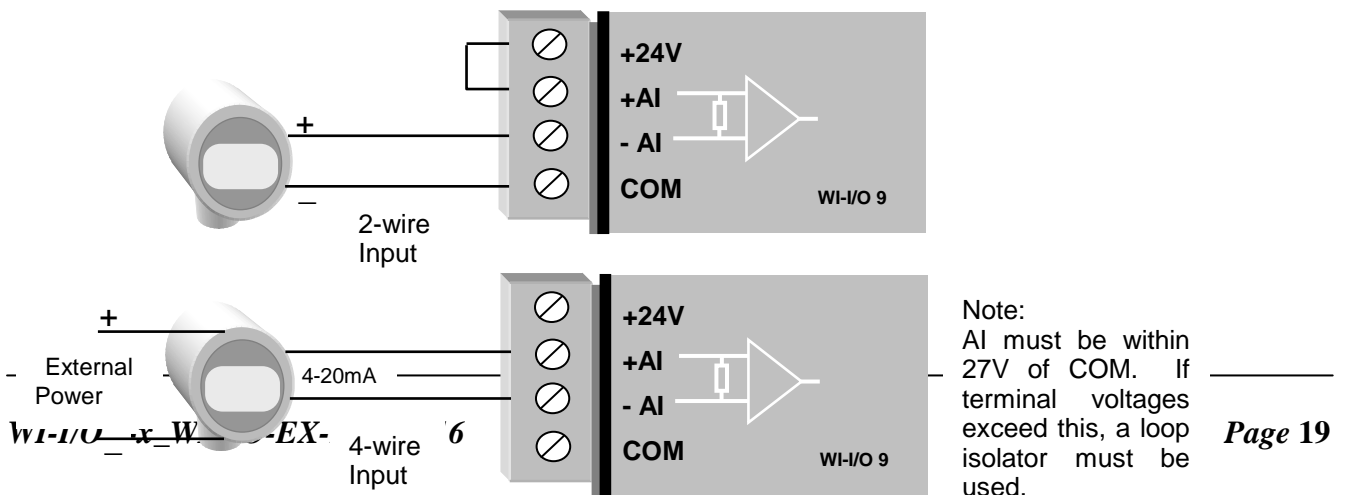

loop, as long as neither input rises above the 24 volt supply level. Each input has a loop resistance of less than 250 ohms and zener diode protection is provided against over-voltage and reverse voltage, however additional protection may be required in high voltage or noisy environments or for very long wiring runs.

A 24VDC loop supply is available on the module for powering the analog transducer loops. In this case, the analog loop should be connected between a "AI 1-" terminal and "COM" (for the first analog input) or "AI 2-" (for the second analog input), and so on for other inputs.

The positive terminal ("AI 1+" or "AI 2+", etc) should be connected to "+24V".

Externally powered loops may be connected by connecting the input between "AI 1+" and "AI 1-" for analog input 1 or "AI 2+" and "AI 2-" for analog input 2, and so on for other inputs. Common mode voltage may be -0.5V to 27V.

Shielded cable is recommended for analog I/O loops to minimise induced noise and Radio Frequency Interference (RFI). The shield of the cable should be connected to earth at one of the cable only. The use of shielded wiring inside an enclosure containing a module is also recommended.

To connect an AI on the WI-I/O 9-x to an analog signal from a PLC or DCS output, check the internal circuit of the output carefully as different devices use different ways to create an analog signal. The following diagram shows two ways of connecting.

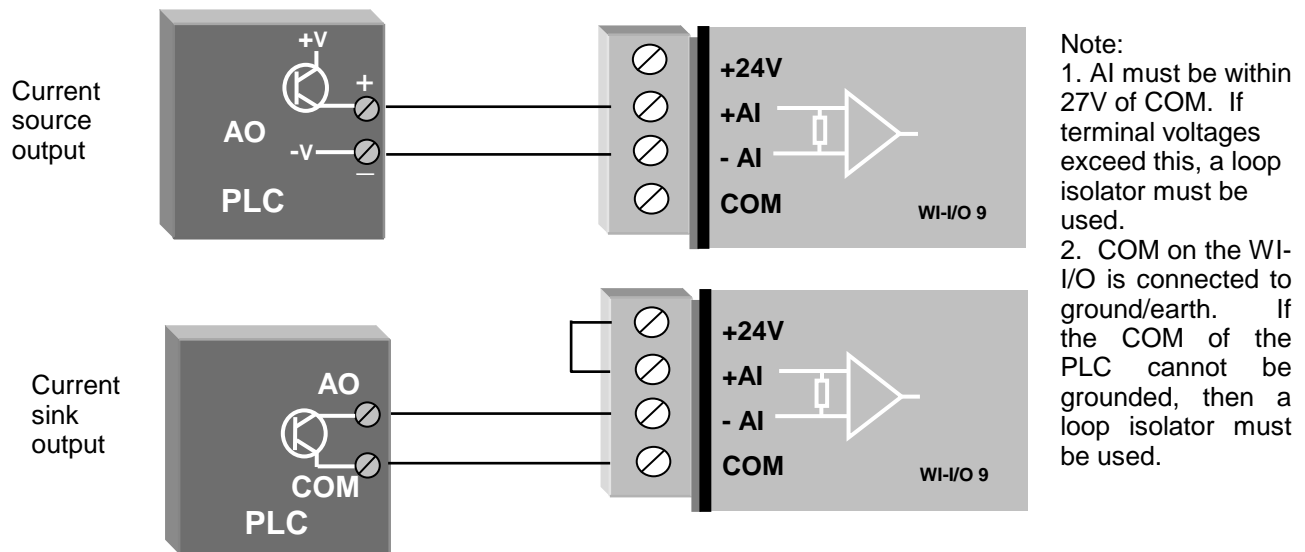

2.4.5 Analog Outputs (WI-I/O 9-1 and WI-I/O 9-3)

The "-1" module provides two 4 - 20 mA DC analog outputs for connecting to instrument indicators for the display of remote analog measurements. The "-3" module provides eight 0 - 20 mA DC analog outputs. Each analog output is a "sink" to common.

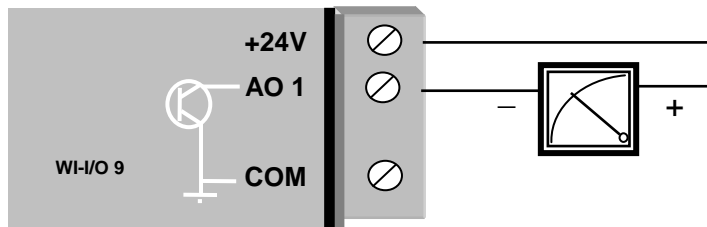

A 24VDC supply is available on the module for powering the analog output loop (max external loop resistance 1000 ohms). In this case, the analog loop is connected between a "+24V" terminal and "AO 1" (for the first analog output) or "AO 2" (for the second analog output), and so on for the other output signals.

If connecting to an external device such as an electronic indicator, recorder or PLC / DCS input, the loop can be powered by either the WI-I/O 9-x or the device. Externally powered loops to 27 VDC may be connected by connecting the output between the "AO" terminal (positive) and the "COM" terminal (negative). Zener protection of analog outputs provides protection against short periods of over-voltage but longer periods **may result in module damage**.

Note that the common is connected internally to ground and no other point in the analog loop should be grounded. If the external device has single-ended grounded inputs, then a signal isolator must be used.

Analog outputs may also be configured to individually turn off (0 mA) if no command message is received to that output for a certain period. . See Chapter 4 **Configuration** for further details.

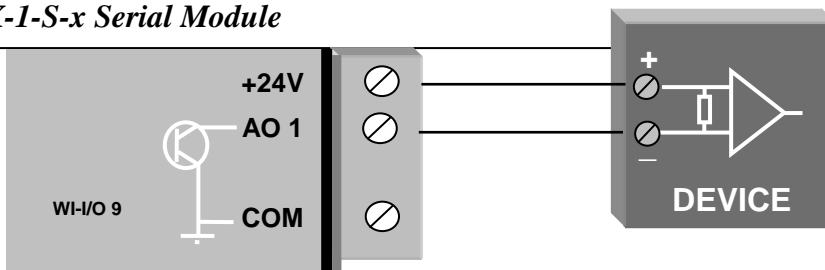

Connecting to a floating input device, powered from the WI-I/O 9-x

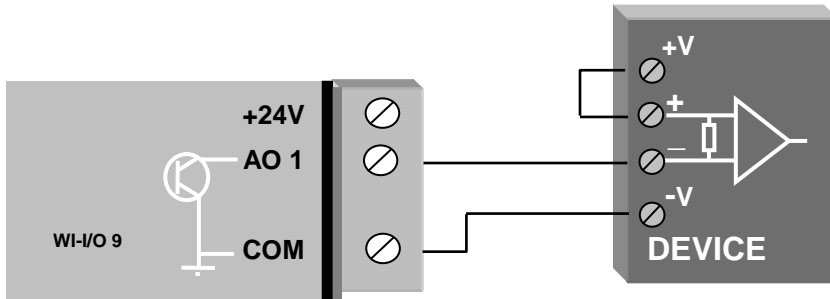

Note:
COM on WI-I/O 9-x
is connected to
ground/earth. If
the external power
supply cannot be
grounded, a loop
isolator must be
used.

Connecting to an externally powered floating-input device

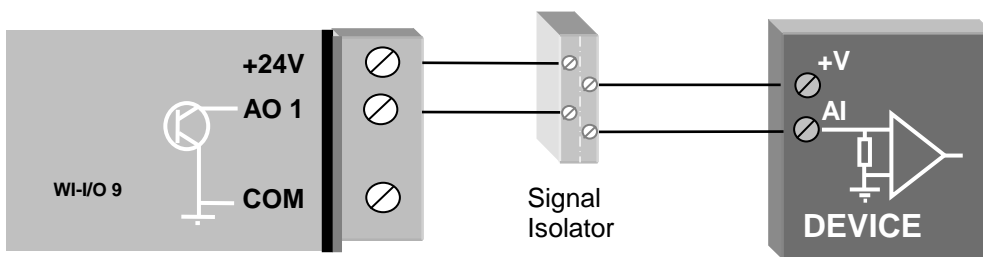

Connecting to a grounded input device via a signal isolator

2.4.6 Pulse Input (WI-I/O 9-1)

For the "-1" module, digital input 1 may be configured as a pulse input (max rate 100 Hz, min. off time 5 ms). In this mode, both the pulse **rate** and the pulse **count** are available for mapping to a remote output. The pulse rate may appear at any analog output on the remote unit, while the pulse count can appear at a Pulse Output on another "-1" or Digital/Pulse Output on a "-3" or "-4" unit. The pulse input should be connected in the same way as a digital input.

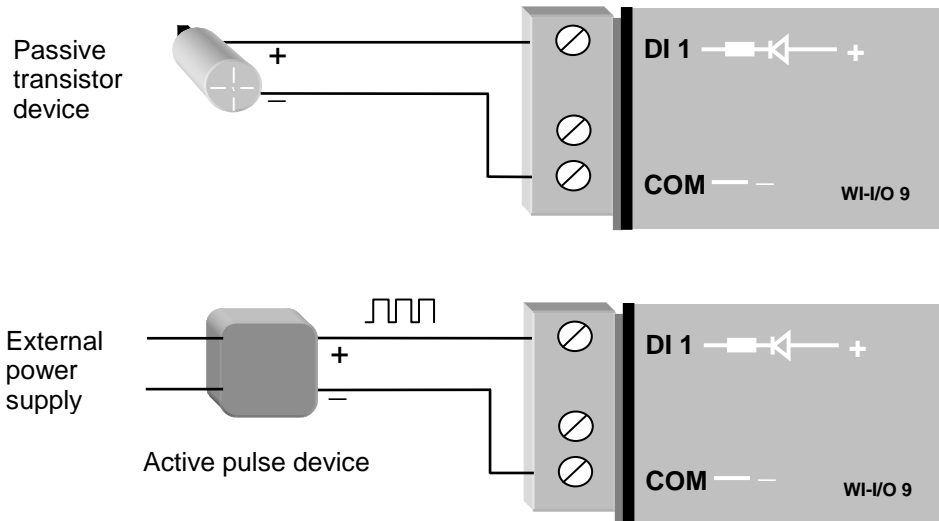

Active pulse signals can be connected directly provided the peak voltage is between 3.5–13V and the low voltage is less than 1.5V. Note that the WI-I/O 9-x will ground the negative of the pulse signal. If the voltages are not compatible, use a solid state relay to isolate the two devices.

2.4.7 Pulse Inputs (WI-I/O 9-2 and WI-I/O 9-4)

For the "-2" and "-4" modules, the four digital inputs (DI 1-4) may be configured as pulse inputs. The first digital/pulse input DI 1 has a maximum rate of 1000 Hz (min. off time 0.5 ms), while DI 2-4 have a maximum rate of 100 Hz (min. off time 5 ms). When using DI 1 at high pulse rates (more than 100 Hz), a divide by 10 function may be configured to reduce the pulse count at the output, as Pulse Outputs have a maximum rate of 100 Hz.

For each pulse input, both the pulse **rate** and the pulse **count** are available for mapping to a remote output. The pulse rate may appear at any analog output on the remote unit, while the pulse count can appear at a Pulse Output. The default update time for pulse counts is 1 minute. This can be changed by changing the update time configuration (refer Chapter 4 **Configuration** for further details). The pulse count is a 16 bit value - "roll over" of the count when it exceeds the maximum value is automatically handled by the modules.

2.4.8 Pulse Output (WI-I/O 9-1)

A single FET output to common rated at 30VDC, 500 mA is provide for the pulse output "PO". This output accurately recreates the pulses counted at a pulse input at another module.

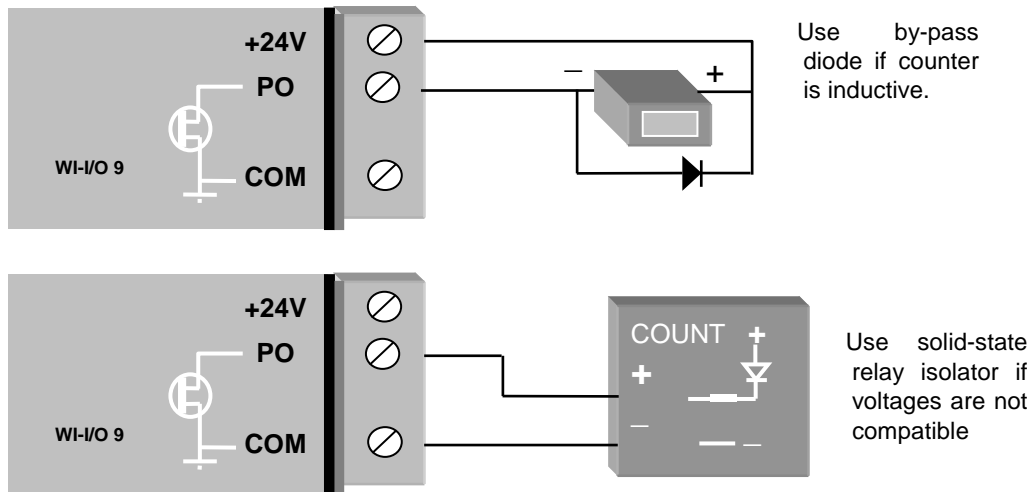

If the counter device requires a voltage pulse signal (such as electronic or elector-mechanical counters), use the 24V analog loop supply, or the 12V BAT supply for the voltage source. Use a by-pass diode if the counter is inductive.

Some devices such as PLC counter modules power the pulse loop. For these devices, connect to the PO and COM terminals of the WI-I/O 9-x. The COM terminal will connect a ground/earth to the external device. If this is not suitable, use a solid state relay to isolate the external device.

Although the count is accurately re-created, the rate of output pulses may not accurately reflect the input rate. The actual input pulse rate may be configured to appear at an analog output if required. Note that the pulse rate and accumulated value will remain accurate even if a period of communications failure has occurred. The maximum output rate is 100 Hz.

2.4.9 Pulse Output (WI-I/O 9-3 and WI-I/O 9-4)

The first four digital outputs on the "-3" and "-4" modules may also be used as pulse outputs. The outputs are FET output to common rated at 30VDC, 500 mA. The outputs will provide a pulse signal of up to 100 Hz. The outputs accurately recreate the pulses counted at pulse inputs at a "-1", "-2" or "-4" module.

Although the count is accurately re-created, the rate of output pulses may not accurately reflect the input rate. The actual input pulse rate may be configured to appear at an analog output if required. Note that the pulse rate and accumulated value will remain accurate even if a period of communications failure has occurred.

2.4.10 RS232 Serial Port

The serial port is a 9 pin DB9 female and provides for connection to a terminal or to a PC for configuration, field testing and for factory testing. This port is internally shared with the RS485 - ensure that the RS485 is disconnected before attempting to use the RS232 port. Communication is via standard RS-232 signals. The WI-I/O 9-x_WI-I/O-EX-1-S-x is configured as DCE equipment with the pin-out detailed below. The serial port communicates at a baud rate of 9600 baud, 8 bits, no parity, one stop bit. An example cable drawing for connection to a laptop is detailed below:

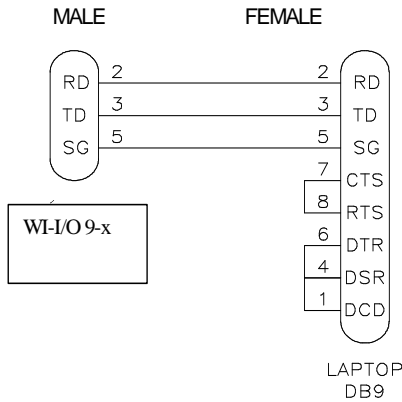

Pin	Name	Dirn	Function
1	DCD	Out	Data carrier detect - not used
2	RD	Out	Transmit Data - Serial Data Input (High = 0, Low = 1)
3	TD	In	Receive Data - Serial Data Output (High = 0, Low = 1)
4	DTR	In	Data Terminal Ready - not used
5	SG	-	Signal Ground
6	DSR	Out	Data Set Ready - not used
7	RTS	In	Request to Send - not used
8	CTS	Out	Clear to send - not used
9	RI	-	Ring indicator - not used.

2.4.11 RS485 Serial Port

The RS485 port provides for communication between multiple units using a multi-drop cable. Up to 32 units may be connected in each multi-drop network. Each multi-drop network may have one unit providing radio communications with other units in the system. The RS485 feature allows local hubs of control to operate without occupying radio bandwidth required for communication between remotely sited units.

The RS485 Communications format is 9600 baud, 8 data bits, one stop bit, no parity. Note that the RS485 port is shared internally with the RS232 port - disconnect the RS232 cable after configuration is complete.

RS485 is a balanced, differential standard but it is recommended that shielded, twisted pair cable be used to interconnect modules to reduce potential Radio Frequency Interference (RFI). An RS485 network should be wired as indicated in the diagram below and terminated at each end of the network with a 120 ohm resistor.

The modules include a terminating resistor on-board. If the WI-I/O 9-x module is the first or last module in the RS485 chain, then the terminating resistor may be connected by operating the single DIP switch in the end-plate next to the RS485 terminals. “On” or “down” means that the resistor is connected.

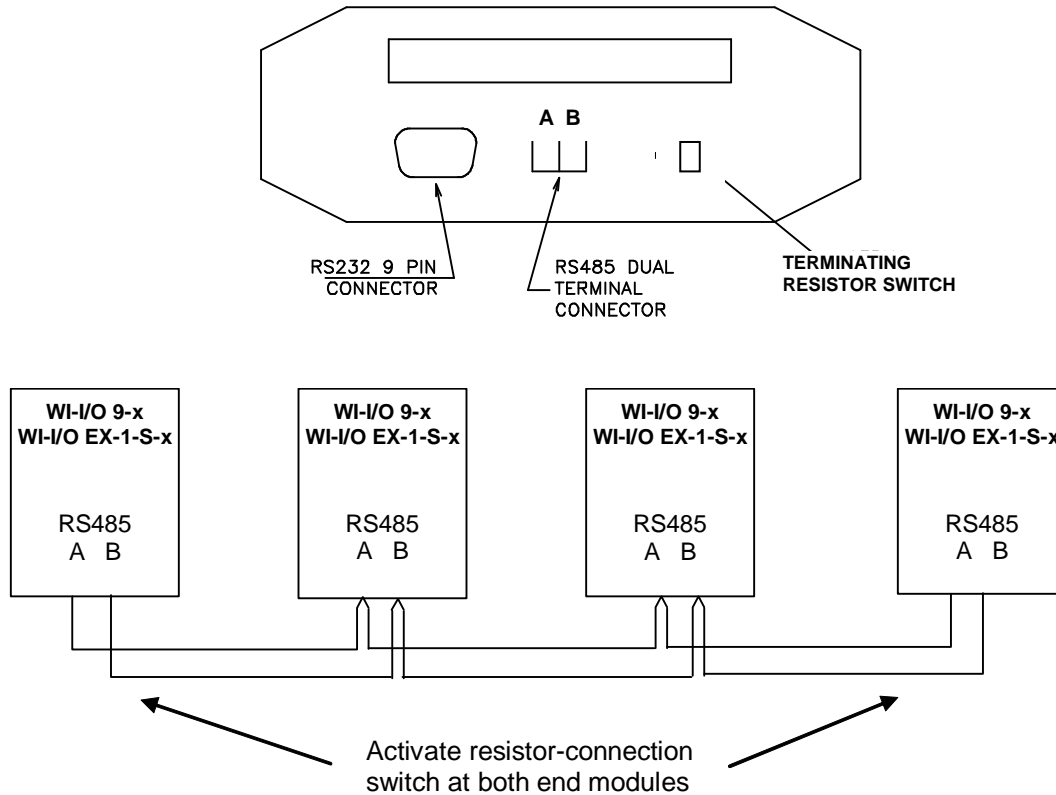

2.4.12 Connecting WI-I/O-EX-1-S-x Modules to WI-I/O 9-x Modules

WI-I/O-EX-1-S-x modules connect to a WI-I/O 9-x via the RS485 port on each module (refer to section 2.4.11). Up to 31 x WI-I/O-EX-1-S-x modules can be connected to a WI-I/O 9-x module. This number is reduced for WI-I/O-EX-1-S-3 and -4 modules, as these modules use two unit addresses (refer to chapter 4 of this manual).

The WI-I/O-EX-1-S-x modules can be mounted next to the WI-I/O 9-x module, or they can be remote from the WI-I/O 9-x. The reliable distance for a RS485 multi-drop line depends on the shielding of the wire and how close it is installed to electrical noise sources - distances of more than ½ mile (1 km) can be achieved by good installation methods. External RS485 isolators are recommended if the earth potential difference between modules is greater than 7V.

3.1 Power-up and Normal Operation

When power is initially connected to the module, the module will perform internal diagnostics to check its functions. The following table details the status of the indicating LED's on the front panel under **normal** operating conditions.

LED Indicator	Condition	Meaning
OK	On	Normal Operation
RX	Occasional flash	Radio Receiving, or Activity on serial ports
RX	Flashes continuously	Configuration Mode
RX	On	Button press when entering Configuration Mode
TX (only on WI-I/O 9-x units)	Occasional flash	Radio Transmitting
PWR	On	Supply voltage available from Solar Panel or SUP1/SUP2
OK	Flashes every 5 seconds	+24V Supply overloaded

Additional LED's provide indication of the status of digital inputs and outputs. LED's display the status of each digital input (lit for active), and LED's display the status of each digital output (lit for active). Other conditions indicating a fault are described in Chapter Six **Troubleshooting**.

The module monitors the power supply and provides status of supply failure and battery low voltage for "mapping" to one of the module's own outputs or transmitting to a remote output. When the module is powered from a normal supply (i.e. via either of the "SUP" terminals), the *PWR* LED indicator is lit. When the module is powered from a solar panel and battery, the *PWR* LED indicator is lit only when the charge current is available (i.e. when the solar panel is receiving light).

If a backup battery is connected, the module will generate a low battery voltage status when the voltage has dropped to 11.3V for approx 45 seconds. This status may be transmitted to another module. In the event of excessively low battery voltage (10.8V), the *OK* LED will go off, the unit will automatically set all outputs off, and disable the +24V analog loop supply. The *OK* LED will turn on again after the battery voltage exceeds 11.8V. This enables installations to be configured so that the battery current drain is minimised in the event of extended mains failure, reducing the possibility of deep discharge of batteries.

3.1.1 Communications

Before each transmission, the WI-I/O 9-x radio will "listen-before-transmit" to make sure that another module is not already transmitting - if there is another transmission, the WI-I/O 9-x will wait until the transmission is complete. When the WI-I/O 9-x transmits, it will wait for a return "acknowledgement" message from the destination module, indicating a successful message. If transmissions are not

successful (radio or serial), then the module will re-try up to four times at random intervals to transmit the message.

Example of Successful Communications

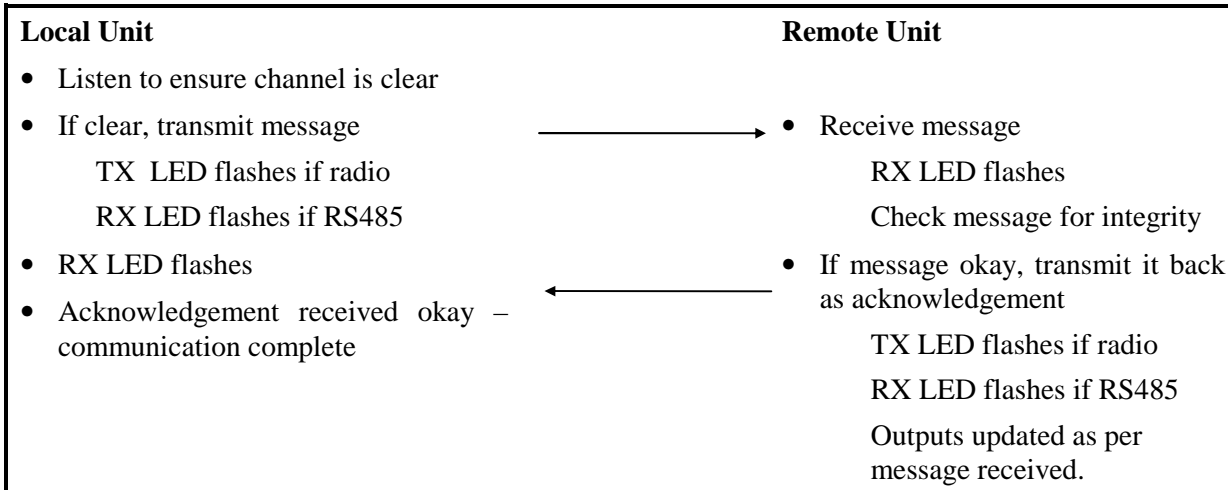

Example of unsuccessful communications

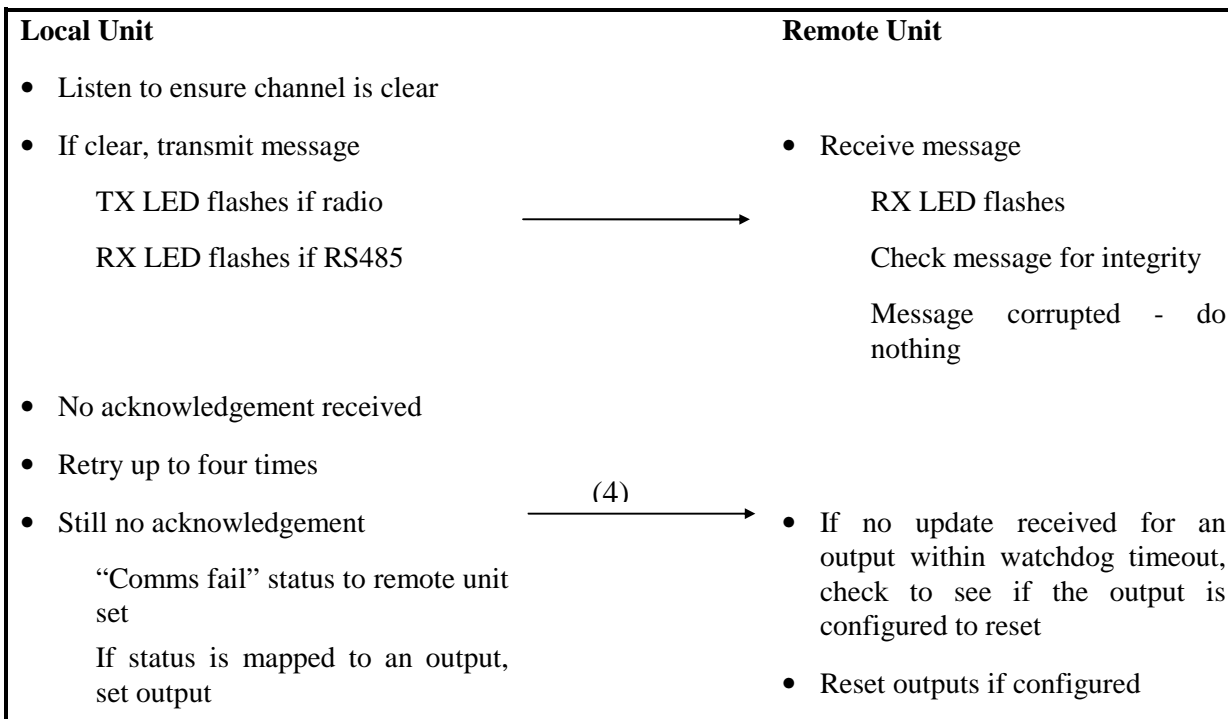

If communications is still not successful, the “Comms Fail” internal status will be set. In the default configuration, this will have no consequence and the module will continue to attempt to transmit to the remote module every ten minutes. For critical applications, the “comms fail” status can be configured to be reflected to an output on the module for alert purposes. The outputs on the module may also be configured to reset after a specified timeout (digital outputs reset to “off”, analog outputs reset to 0 mA)

allowing the system to turn off in a controlled manner e.g. a pump will never be left running because of a system failure.

Note: The WI-I/O 9-x will hop frequencies for each re-try transmission - each re-try will follow at approx 0.5 sec after the last. So a WI-I/O 9-x will complete all re-tries in less than 3 seconds.

Repeaters can be used in a system to increase range. Each WI-I/O 9 unit can be configured to act as a repeater. When configuring an input to be mapped to an output, the communications path to the output unit, including the repeater addresses is specified. The WI-I/O 9-x acts as a *store&forward repeater*, that is, the signal is decoded and then retransmitted “as new”.

Example Repeater Communications

Unit A DI 1 mapped to Unit D DO1 via Units B & C

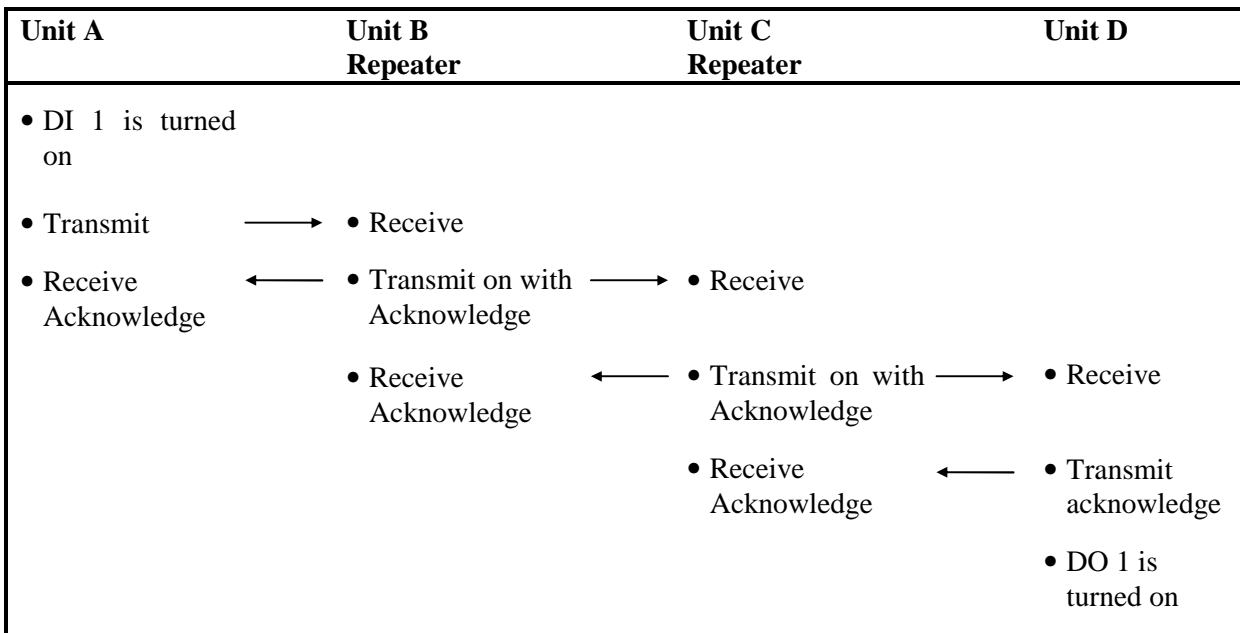

3.1.2 Change of state conditions

The module transmits a data message whenever it detects a "change-of-state" on one of its input signals. A "change-of-state" of a digital or digital internal input is a change from "off" to "on" or vice-versa provided the change is sustained for 0.5 second (i.e. 0.5 second debounce). The debounce delay is configurable.

In addition to "change-of-state" transmissions, each module will transmit the status of each input to its corresponding output every ten minutes (configurable). These **updates** mean that the outputs are set to the current input values regularly, even where no “change-of-state” has occurred. These update transmissions increase the accuracy of the output and give extra system reliability.

Analog Change-of-state

A "change-of-state" for an analog input, battery voltage or pulse input rate is a change in value of the signal of 3% (configurable) since the last transmission. Note that the sensitivity of 3% refers to 3% of the analog range, not 3% of the instantaneous analog value. That is, if an analog input changes from 64% (14.24 mA) to 67% (14.72 mA), a "change-of-state" will be detected. This “change-of-state”

sensitivity is configurable between 0.8% and 75%.

Analog inputs are digitally filtered to prevent multiple transmissions on continually varying or "noisy" signals. The input is filtered with a 1 second time constant and a 1 second debounce. The analog outputs are filtered with a 1 second time constant. An **example** of an **analog** input and how the output follows it is shown below:

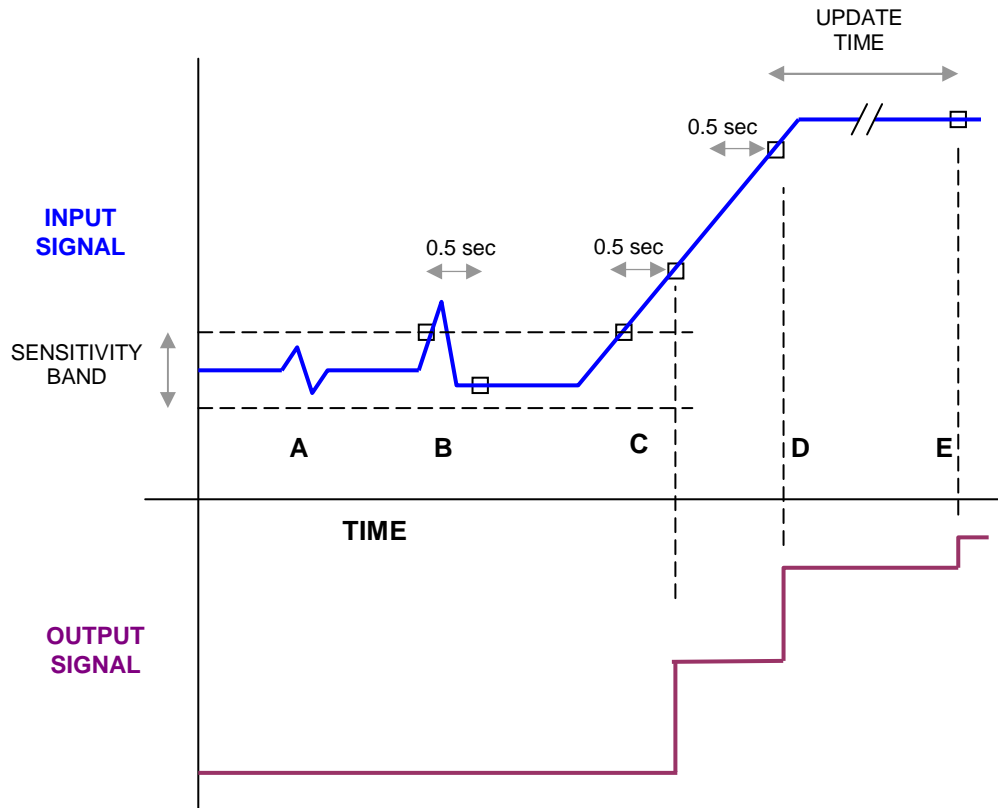

- A No transmission as the sensitivity band was not exceeded
- B The sensitivity band was exceeded, however the input returned to within the sensitivity band before the 0.5 sec debounce time - no transmission
- C Transmission occurs 0.5 sec after the sensitivity band is exceeded.
- D Another transmission 0.5 sec later as the input has changed by more than the sensitivity band
- E The input has not changed by more than the sensitivity, however the update time has elapsed since D.

In general, the following may be used as a rule of thumb for calculating the appropriate sensitivity required for a given application:

Instantaneous change of 2 x sensitivity on input → 3 second output response

Instantaneous change of 10 x sensitivity on input → 5 second output response

The analog inputs have 15 bit resolution and 0.016mA accuracy.

Pulse input change of state

Pulse input counts do not use “change-of-state” transmissions. Instead, accumulated pulse input counts are transmitted at set intervals. The default period is 1 minute and is configurable. The absolute pulse count is transmitted. If the PI is transmitted to a PO on a WI-I/O 9-x_WI-I/O-EX-1-S-x module, then the pulse outputs are re-created from the *accumulated* pulse count. Rollovers of the pulse count thru zero are catered for. If a transmission is missed, the pulse output will still be re-created when the next accumulated value is transmitted. This ensures that no pulses are lost due to communications failures. If the PI is transmitted to a WI-I/O 9-C interface module, then the accumulated pulse count is stored in the WI-I/O 9-C for interfacing to the host device.

The following diagram shows how pulse inputs are re-created as pulse outputs. For pulse outputs, the module keeps two counters in memory - the pulse input count received from the remote module, and the count of output pulses. When the module receives an update of the input pulse count, it will output pulses until the output pulse count is the same as the input pulse count. The output pulse will be output evenly over the pulse output update time which is configured in the module. For example, assume that module receives a pulse input update message from the remote module, and the difference between the pulse input count and the pulse output count is 12 pulses. The module will then output the 12 pulses evenly over the next minute (if the pulse output update time is 1 minute).

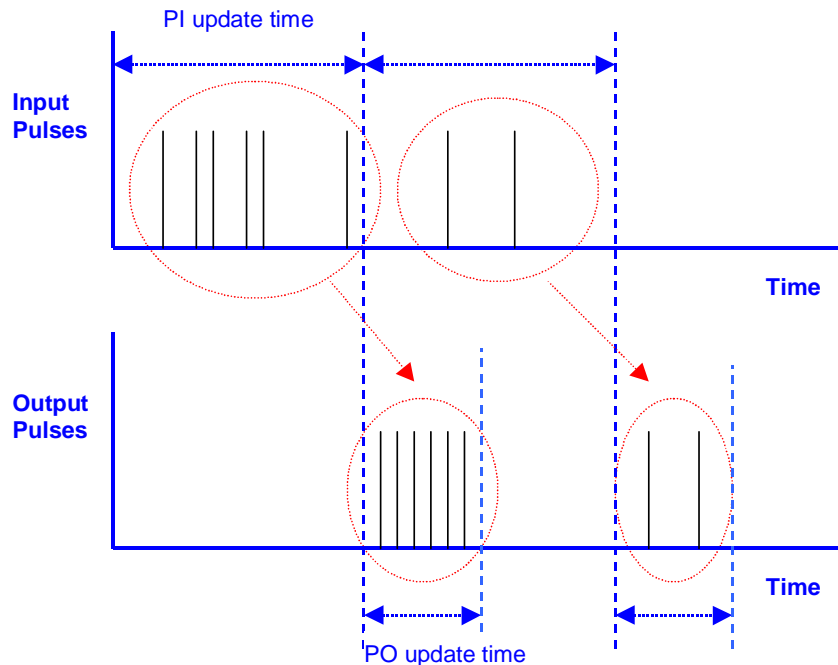

The default values for the pulse input update time and pulse output update time is 1 minute. In this case, the output pulses are effectively 1 minute behind the input pulses. These update times may be changed by the user. The pulse output update time should not be set to be more than the pulse input update time. Note that the maximum pulse rate for both inputs and outputs is 100Hz.

As well as accumulating the pulse input, the module will also calculate the rate of pulses. **Pulse rates** are treated as an “internal” analog input and are configured with analog sensitivities for change-of-state transmissions. The maximum pulse rate corresponding to 20mA output may be configured by the user.

3.1.3 Analog Set-points

On “-1” modules, the “AI 1” input may be used to trigger the analog set-point status. High set point and low set point levels are configurable. This set-point status turns ON when the analog input moves below the low level, and turns OFF when it moves above the high level. The high level must always be greater than, or equal to, the low level set point. This set-point status may be mapped (inverted, if required) to any output in the network. The set-point status is effectively an internal digital input.

On “-2” modules, AI 1 - 4 have set-point values for controlling digital outputs. The set-point operation works as for the “-1” module.

3.1.4 Start-up Poll

After a module has completed its initial diagnostics following power up, it will transmit update messages to remote modules based on the values of the module’s inputs. The module’s outputs will remain in the reset/off/zero condition until it receives update or “change-of-state” messages from the remote modules.

The module can transmit a special “start-up poll” message to another module. The remote module will then immediately send update messages to this module such that its outputs can be set to the correct value. Start-up polls will only occur if they are configured. It is necessary to configure a start-up poll to each remote module which controls the module’s outputs. For further information (refer to Chapter 4 Configuration).

3.1.5 Communications Failure (CF)

The internal communications failure (CF) status is set if a module does not receive an acknowledgement message after five attempts at transmitting a message. The CF status may be configured to set a local digital output for an external alarm.

Although the CF status can set an output, it will not reset the output. That is, once communications is re-established (and the CF status is reset), the output will stay “on”. The Reset Output feature (see below) is used to reset the output.

The output will reset only when no communications failures occur within the configured “Reset Output Time” for the output that CF status is mapped to. Note that if the reset output time is not enabled, the CF status will remain set forever, once an unsuccessful transmission occurs. See Chapter 4 **Configuration** for further details.

For a link with one or more repeaters, the internal CF status will only set for a failure between the transmitting module (the source module) and the first repeater. If the communications failure occurs after the first repeater, then the source module CF status will not set. To indicate comms status on this type of link, the “Reset Output” function should be used.

3.1.6 Resetting Outputs

Each digital and analog output may be individually configured to reset if that output has not received a change-of-state or an update message within a certain time period. Generally this time is set to twice the update period, so at least one update can be missed before an output is reset.

In most cases it is desirable to reset outputs which are controlling equipment if there is a system failure, however alarm or indication outputs are not reset so the last valid indication remains shown. See Chapter 4 **Configuration** for further details.

3.2 System Design Tips

The following tips will help to ensure that your system operates reliably.

3.2.1 System Dynamics

It is important to be aware of the dynamics of the system. Inputs have a configurable “debounce” delay (default 0.5 sec) - that is, a change message will not be sent for 0.5 sec after a change has occurred. This avoids transmitting spurious noise on the input signal. If you require faster (or slower) operation, change the debounce setting.

Messages transmitted via serial link are received in less than 20 m/sec., however a message sent by radio takes approx 60 m/sec.

These delays are not significant in most applications, however if your application requires faster responses, then the above delays need to be considered.

3.2.2 Radio Channel Capacity

Messages sent on a cable link are much faster than on a radio channel, and the capacity of the radio channel must be considered when designing a system. This becomes more important as the I/O size of a system increases.

The modules are designed to provide “real-time” operation. When an input signal changes, a change message is sent to change the output. The system does not require continuous messages to provide fast operation (as in a polling system). Update messages are intended to check the integrity of the system, not to provide fast operation. Update times should be selected based on this principle. The default update time is 10 minutes - we recommend that you leave these times as 10 minutes unless particular inputs are very important and deserve a smaller update time.

It is important that radio paths be reliable. For large systems, we recommend a maximum radio channel density of 100 messages per minute, including change messages and update messages. We suggest that you do not design for an average transmission rate of greater than 40 per minute - this will give a peak rate of approx 100 per minute. Note that this peak rate assumes that all radio paths are reliable - poor radio paths will require re-try transmissions and will reduce the peak channel density. If there are other users on the radio channel, then this peak figure will also decrease.

Dual Band Operation

The WI-I/O 9-x radio band is split into two sub-bands, 902-915 MHz and 915 – 928 MHz . In America

and Canada, the WI-I/O 9-x uses both sub-bands - but in other countries, only the high sub-band. In America and Canada, it is possible to restrict the frequency hopping of the WI-I/O 9-x to only the high or low band. If there are many WI-I/O 9-x systems in the same area, this technique will help to separate systems to avoid radio interference. Note that this technique is only possible in America / Canada.

The radio sub-band can be selected by the “system address” - refer section 4 of this manual. An odd system address selects the low band, and an even system address selects the high band.

3.2.3 Radio Path Reliability

Radio paths over short distances can operate reliably with a large amount of obstruction in the path. As the path distance increases, the amount of obstruction which can be tolerated decreases. At the maximum reliable distance, “line-of-sight” is required for reliable operation. If the path is over several kilometres (or miles), then the curvature of the earth is also an obstacle and must be allowed for. For example, the earth curvature over 5 miles (8km) is approx 10 feet (3m), requiring antennas to be elevated at least 13 feet (4m) to achieve “line-of-sight” even if the path is flat.

A radio path may act reliably in good weather, but poorly in bad weather - this is called a “marginal” radio path. If the radio path is more than 20% of the maximum reliable distance (see Specification section for these distances), we recommend that you test the radio path before installation. Each WI-I/O 9-x module has a radio path testing feature - refer to section 6.2 and 6.3 of this manual.

There are several ways of improving a marginal path :-

- Relocate the antenna to a better position. If there is an obvious obstruction causing the problem, then locating the antenna to the side or higher will improve the path. If the radio path has a large distance, then increasing the height of the antenna will improve the path.
- Use an antenna with a higher gain. Before you do this, make sure that the radiated power from the new antenna is still within the regulations of your country. If you have a long length of coaxial cable, you can use a higher gain antenna to cancel the losses in the coaxial cable.
- If it is not practical to improve a marginal path, then the last method is to use another module as a repeater. A repeater does not have to be between the two modules (although often it is). If possible, use an existing module in the system which has good radio path to both modules. The repeater module can be to the side of the two modules, or even behind one of the modules, if the repeater module is installed at a high location (for example, a tower or mast). Repeater modules can have their own I/O and act as a “normal” WI-I/O 9-x module in the system.

3.2.4 Design for Failures

All well designed systems consider system failure. I/O systems operating on a wire link will fail eventually, and a radio system is the same. Failures could be short-term (interference on the radio channel or power supply failure) or long-term (equipment failure).

The modules provide the following features for system failure :-

- Outputs can reset if they do not receive a message within a configured time. If an output should

receive an update or change message every 10 minutes, and it has not received a message within this time, then some form of failure is likely. If the output is controlling some machinery, then it is good design to switch off this equipment until communications has been re-established.

The modules provide a “drop outputs on comms fail” time. This is a configurable time value for each output. If a message has not been received for this output within this time, then the output will reset (off, in-active, “0”). We suggest that this reset time be a little more than twice the update time of the input. It is possible to miss one update message because of short-term radio interference, however if two successive update messages are missed, then long term failure is likely and the output should be reset. For example, if the input update time is 3 minutes, set the output reset time to 7 minutes.

- A module can provide an output which activates on communication failure to another module. This can be used to provide an external alarm that there is a system fault.

3.2.5 Indicating a Communications Problem

There are two ways to provide an indication of communications problems.

Fail-to-transmit alarm. The first is to map the internal CF status to a local output, to generate a “fail-to-transmit” alarm. The configured output will activate when a comms fail occurs - that is, when the module attempts to transmit a message five times without an acknowledgement. This method provides an indication immediately an attempt to transmit a message fails. If you want the radio path to be “tested” regularly, then you need to configure the update times such that transmissions occur regularly (however do not overload the radio channel).

Notes regarding this method:

1. Each CF mapping corresponds to only one remote address - you need to make separate mappings for each remote address. You can map the CF for each remote module to a separate output, or to the same output.
2. You need to reset the comms fail output using the “reset output” parameter. Select a reset time which is greater than the effective update time period. For example, if there are four inputs mapped from module #1 to module #2, each with a 10 minute update, then you would expect at least four transmissions in each 10 minute period. At module #1, a comms fail for #2 is mapped to DO1. If you set the “reset time” for DO1 to 10 minutes, then there will be at least four transmissions made during the reset period - that is, the output will only reset when the communications has been successful four times.
3. This method will not work for radio links with repeaters. If a repeater is used, you will need to use the second method described below.

Fail-to-receive alarm. The second method is to set up a “comms OK” output using the “Reset Outputs” function. The output is normally on, indicating “comms OK”, and will reset if the module does not receive a message from the remote module within the configured reset time.

Consider a link between module #1 and #2, and assume that you want a “comms OK” output at #1. At #2, map an unused input to an output at #1 such that the output is normally active (‘on’). If there is no spare inputs at #2, you can use an internal input such as “low voltage status”. You will need to invert the mappings such that the output is normally on (because the input is normally off).

At #1, configure a reset time for the output. The reset time should be greater than the update time for the mapping at #2. If #1 fails to receive update messages from #2, then the output will reset, indicating a communications failure. Notes regarding this method:

1. This method will work with repeaters in the link.
2. The “comms OK” output is fail-safe - if module #1 fails, then the output will reset indicating a problem.
3. You should use separate outputs to indicate “comms OK” of different remote modules.
4. It is recommended that you set the reset time at #1 to more than twice the update time of the mapping at #2. This means that the comms OK output will only reset if #1 misses two consecutive updates from #2.

3.2.6 Testing and Commissioning

We recommend that you set-up and test the system with all of the modules together **before** you install the modules. It is much easier to find a configuration problem.

When the system is configured, record the radio signal strength and background noise level for each radio link. If there are future communications problems, you can compare the present measurements to the as-commissioned values. This is an effective way of finding problems with antennas, cables and also changes in the radio path (for example, the erection of new buildings).

3.3 Security Considerations

There are three dimensions of security considerations:

1. Failure to operate when required - or “operational reliability”.
The features discussed above optimize operating reliability. Using an acknowledgement and re-try protocol ensures that the transmitting module is aware whether the transmitted message has been transmitted reliably. The “fail to transmit” and “fail to receive” alarms provide indication if the radio link has failed to operate.
2. Mal-operation, or operating when not requested.
This problem occurs when an output is “triggered” by the wrong radio device. The WI-I/O 9-x modules use frequency encoding and a very secure addressing system to ensure this does not occur. An additional security level using data encryption can also be selected.
3. Malicious operation, or “hacking”
This is the problem most associated with security concerns - the ability for someone to access information from a radio system by “listening-in”, or to cause damage by transmitting radio messages to force outputs.

A security option can be selected during the module configuration to protect against this. The security option (if selected) adds data encryption to radio messages. Modules in the same system are

automatically configured with the encryption key, such that only these modules can understand each other. “Foreign” modules will hear the messages, but cannot decrypt the messages. For more information, refer to section 4.3.7.

Chapter Four

CONFIGURATION

4.1

Introduction

The modules are configured by connecting a computer (PC) using the Configuration Software program. The same software program is used to configure WI-I/O 9-x and WI-GTWY-9-xxx modules - for more information, refer to the separate User Manuals for these products.

Each module is configured with a system address and a unit address. The system address is common to every module in the same system, and is used to prevent "cross-talk" between modules in different systems. Separate networks with different system addresses may operate independently in the same area without affecting each other. The system address may be any number between 1 and 32 767. The actual value of the system address is not important, provided all modules in the same system have the same system address value. **A system address of zero should not be used.** The configuration program automatically offers a random number for the system address - you can change this to any number in the valid range but we recommend that you use the random number.

Each module must have a unique unit address within the one system. A valid unit address is 1 to 127. A network may have up to 95 addresses communicating via radio (unit addresses 1 to 95), each with up to 31 modules communicating via RS485 (unit addresses 96 to 127). In the network, any individual input signal may be "mapped" to one or more outputs anywhere in the system. The unit address determines the method of communication to a module. Any module with a unit address between 96 and 127 will communicate by RS485 only. Other units with a unit address below 95 may communicate by radio *or* RS485 - the unit will determine which way to communicate depending upon the unit address of the destination module. For example, Unit 31 will talk to Unit 97 by RS485 only, but will talk to unit 59 by radio only. WI-I/O-EX-1-S-x units must always have a unit address between 96 and 127 as serial communication is the only method of communication available. **A unit address of zero should not be used.**

The four different I/O versions in the range can be used together in the same system. WI-I/O 9-x and WI-GTWY-9-xxx modules can also be part of a system. Inputs to one product type can be transmitted to outputs of another product type. For example, an analog input to a "-2" may be transmitted to an analog output of a "-1" or "-3". Repeaters may be any product type.

The "-1" and "-2" modules require only one unit address. The "-3" and "-4" modules use two addresses, however only one unit address has to be entered. The "-3" and "-4" modules require two addresses because of the large number of output channels. If the "entered" unit address is an even number, then the second address is the next number. If the "entered" address is an odd number, then the second address is the previous number. So the two addresses are two subsequent numbers, starting with an even number. If a "-3" module is given a unit address of 10, then it will also take up the unit address 11 and will accept messages addressed to either 10 or 11. It is important to remember this when allocating unit addresses to other modules in the system.

Warning - do not allocate the address number 1 to a "-3" or "-4" module.

In addition to these network configurations, operational parameters called **User Options** may be configured to change the features of the operation.

4.2 Easy Configuration Using Default Settings

If your application requires only a single pair of modules, communicating via radio or serial link, default settings may satisfy your needs. If so, no configuration is required. Essentially, all inputs at Module A are reflected at the corresponding outputs at Module B. All inputs at Module B are reflected at the corresponding outputs at Module A.

For “-1” modules, the default configuration is as follows :-

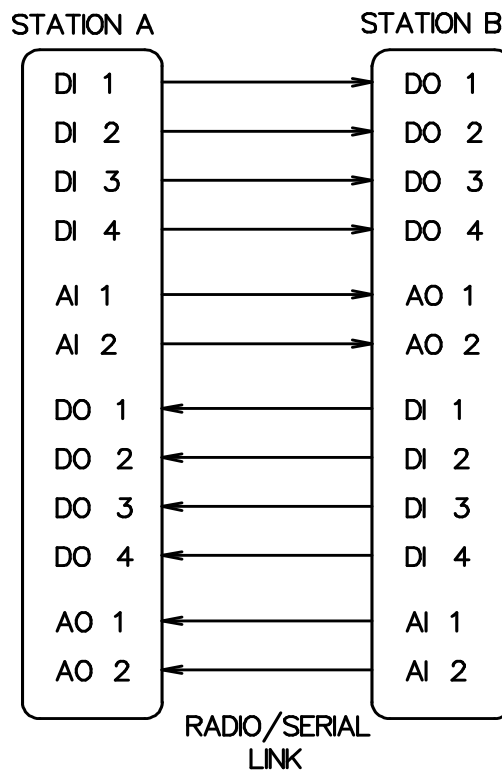

In this configuration, the “PO” Pulse output is inactive and no special action is taken on “Comms fail”, “Mains fail” or “Battery Low”. “DI 1” is configured as a digital and not a pulse input.

For “-2” and “-3” modules, the default configuration is a

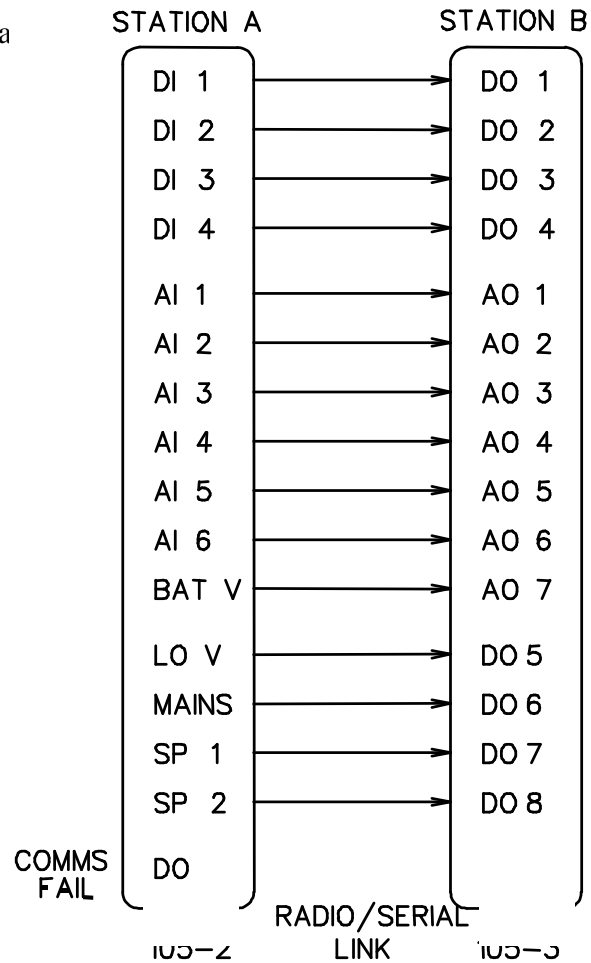

Note that there is no default configuration for the “-4” modules.

The following table details the default values for **User Options**:

Option	Factory Set Value
Update transmissions	Every 10 minutes
Analog Change-of-state sensitivity	3%
Reset outputs on Comms fail	No
Analog Setpoints (if mapped)	Low Set point = 30% High Set point = 75%
Pulse Output Rate Scaling (if Pulse Rate is mapped)	100 Hz
Digital Input Debounce Time	0.5 seconds

If any of the above values are not appropriate to your system, Section 4.4 below will detail how to change one or all of the above variables.

4.3

Configuration Software

This chapter describes installation and telemetry modules. The configuration software creates a configuration file. The configuration software also allows the modification. Configuration files are created.

Configuration of modules consists of mapping. A mapping is a link between an input on a module and an output. A mapping has the form :-

This mapping links DI3 on this module to DI3 and 11 are repeaters.

User Options may be selected to change

Note: Every module must have at least one mapping. Mappings are required (for example, you are required to configure a mapping for a spare input to an unused output).

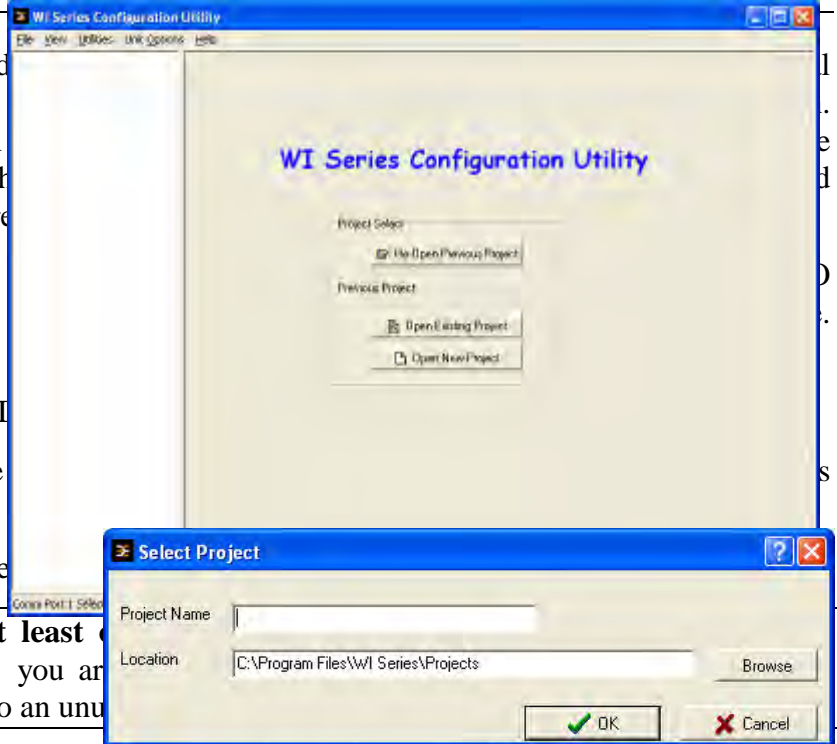

4.3.1 Hardware and Software Requirements

The configuration software is available on a CD, and needs to be installed on your PC before you can use it. The CD contains a setup file called *setup.exe*. Select the configuration software window on the Product CD and an installation Wizard will guide you through the installation procedure. To upload and download configuration files to a module, you will need a RS-232 serial cable as shown below.

4.3.2 Program Operation

Start the software by either clicking on the start bar and navigating to the Configuration menu or by running WISeries.exe in the directory selected in the setup stage.

The Initial screen will appear. The configuration is performed for a complete system. The necessary configuration stages are:

- select system name and system address
- select individual units and unit addresses
- configure I/O mappings for each unit
- configure user options for each unit
- load the configuration files into each unit.

WI-I/O 9 End DB9 Male	PC End DB9 Female
1	1
2	2
3	3
4	4
5	5
6	6
7	7
8	8
9	9

Additional notes from image:
 - Line 3: Required
 - Line 7: Optional

From the initial screen, you can select an existing project, or start a new project. The name of the project will create a new directory which will eventually contain the configuration files for the modules in this system.

When you have selected the project, a screen will appear.

If you are editing an existing project, the system will allow you to change the system address unless you are going to re-

Password. You have the option of entering a password to prevent unauthorized changes. When you open a new project, you do not enter any text - that is, press "ESC" or "Enter". If you enter a password, then you will need to enter the password to download or upload configuration. You only need to enter the password without the password, you are able to view the configuration.

The password can be between 6 and 256 characters. You can change the option from the "Utilities" menu.

If you are starting a new project, you have the option of using the default 4.3.7 and the associated warnings before using the default.

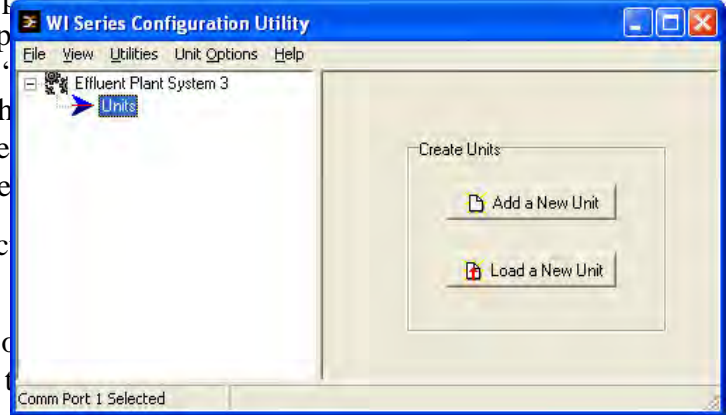
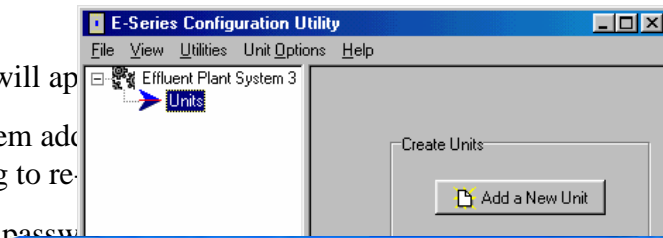

To proceed with the configuration, double-click on the project name on the menu on the left side of the screen. "Units" will appear. You can now enter the types of units which will be used in the system. If you double-click on "Units", then the modules that have already been selected will appear.

Loading configuration from an existing module

To load the configuration from a module, connect the module to the system and click on "Load Unit". This will allow you to view the module configuration from another module - refer to section 4.3.3 for more information.

Adding a new module to the system configuration

To add a new module to the system configuration, click on "Units" on the left-hand menu and then "Add Unit". Select the type of module from the list.

Note that this program covers WI-I/O-EX-1-S-x and WI-I/O 9-x modules. These modules are essentially the same as far as configuration is concerned. That is, a WI-I/O 9-1 selection will configure a WI-I/O-EX-1-S-1 or a WI-I/O 9-1.

The program will ask to select the unit address and will display the list of available addresses for you to select. For WI-I/O 9-x modules, select an address between 1 and 95. For WI-I/O-EX-1-S-x modules, select an address between 96 and 127.

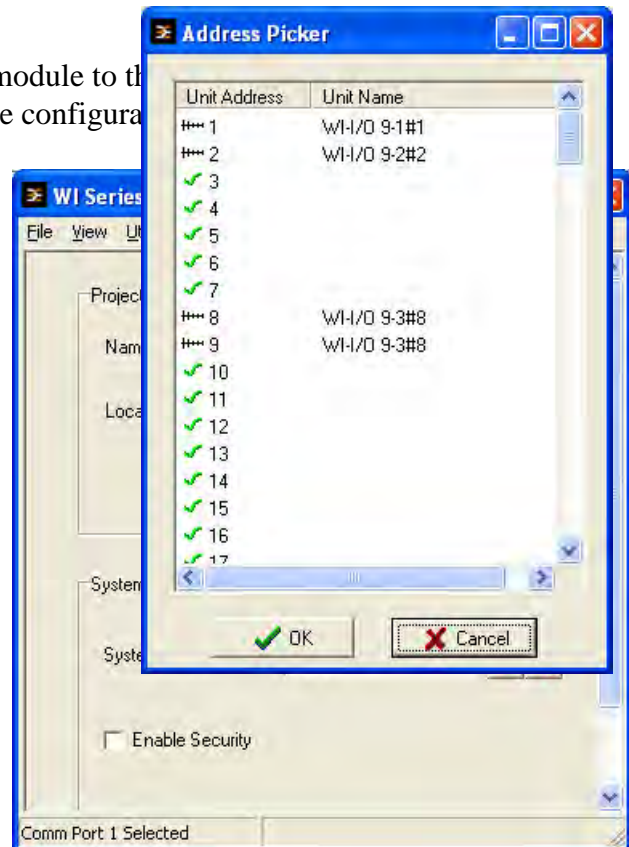

The default name for a unit will include the unit address. For example, “WI-I/O 9-3#8” is a WI-I/O 9-3 module with unit address 8 (and also 9, as a -3 takes two unit addresses). You can change the name

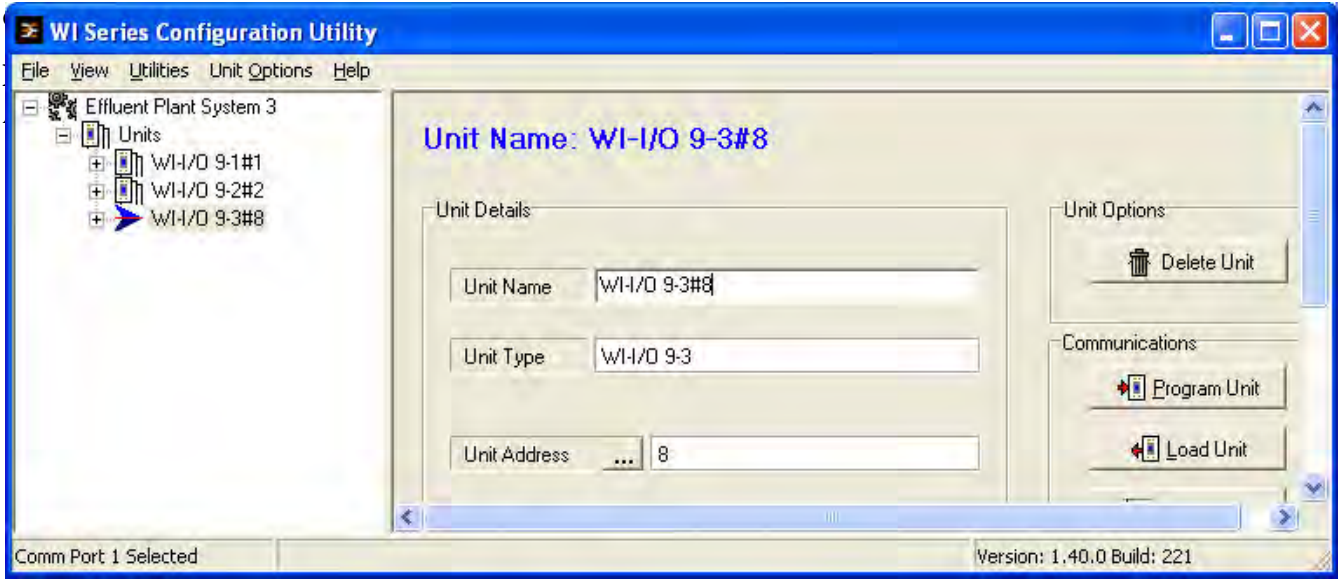

Configuring an individual module

Double-click on a unit shown on the left-hand menu. The configuration options for each unit will appear. We recommend that you configure I/O mappings first, and then other options.

Select “Mappings” and the following screen appears. There are three types of mappings:

- I/O mappings which link inputs to outputs
- Poll mappings, which enables a module on start-up to request set its outputs quickly

Comms Fail mappings, which maps communication failure status to an output on the local module.

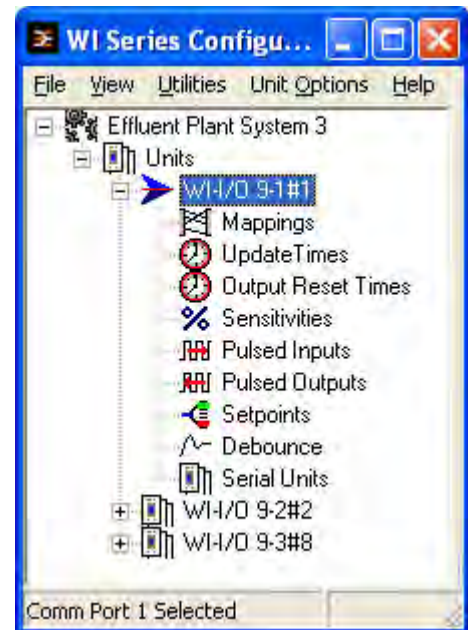

I/O Mapping To enter an I/O mapping, select “New I/O Mapping”.

1. The I/O mapping display will show all inputs at the selected module - both physical inputs and internal inputs. Select the input to be mapped.
2. If you wish to invert the mapping, select the “Invert Input” box. If you invert an input, then the output will be the reverse of the input. Analog I/O can also be reversed - 4mA will be 20mA etc. **Do not invert pulse inputs.**
3. The invert function is not available on -2 modules - only inverted digital inputs are available (as internal inputs on the input list).
4. To select the destination module, you can either select the module from the “Destination Unit” list, or enter the unit address in the “To Destination” box. You can enter an address that has not yet been allocated to another unit.
5. You can select the output by entering the output number (1 – 8) in the “output” box, or select an

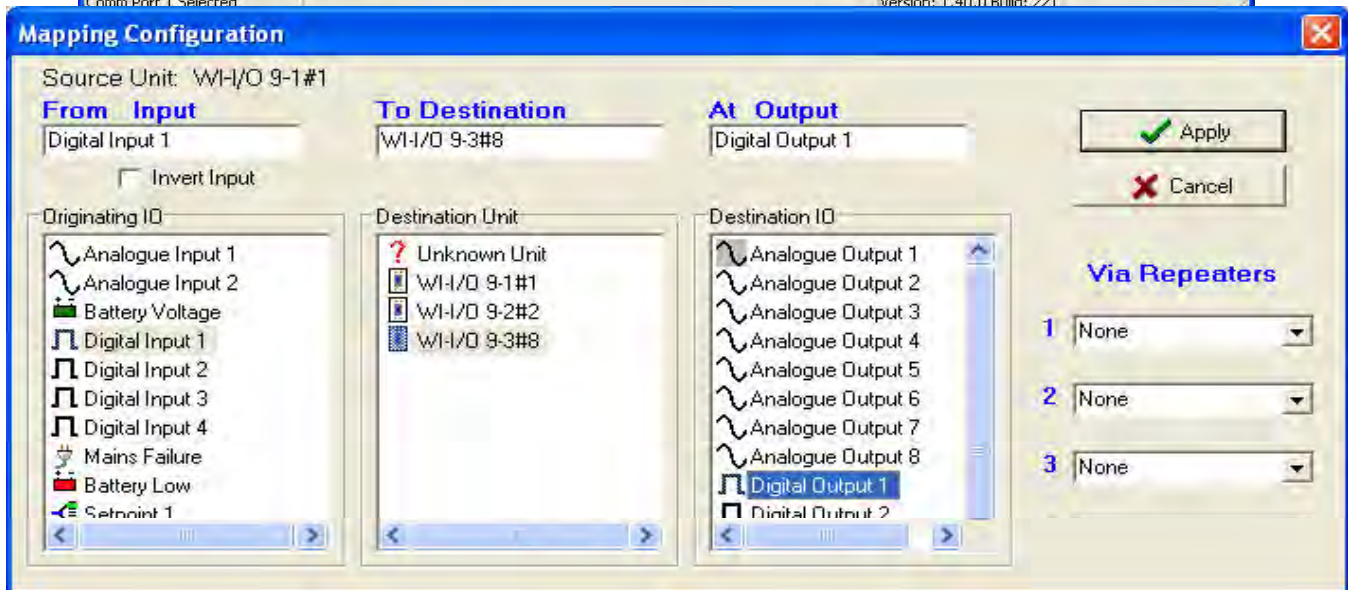
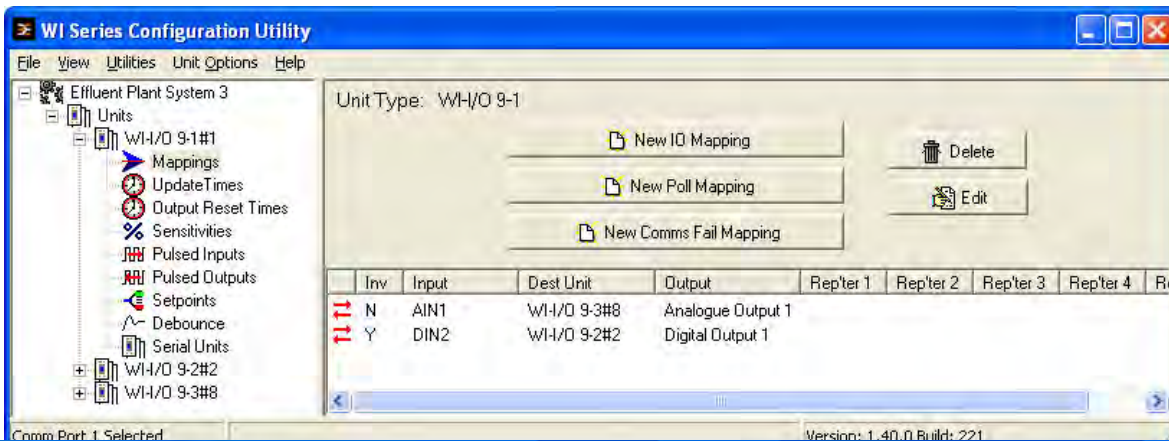

	WI-I/O 9-1	WI-I/O 9-2	WI-I/O 9-3 First addr (Even)	WI-I/O 9-3 Second addr (Odd)	WI-I/O 9-4 First addr (Even)	WI-I/O 9-4 Second addr (Odd)
Output 1	DO 1	DO 1	D/P O 1	AO 1	D/P O 1	DIO 5
Output 2	DO 2	None	D/P O 2	AO 2	D/P O 2	DIO 6
Output 3	DO 3	None	D/P O 3	AO 3	D/P O 3	DIO 7
Output 4	DO 4	None	D/P O 4	AO 4	D/P O 4	DIO 8
Output 5	AO 1	None	DO 5	AO 5	DIO 1	DIO 9
Output 6	AO 2	None	DO 6	AO 6	DIO 2	DIO 10
Output 7	PO	None	DO 7	AO 7	DIO 3	DIO 11
Output 8	None	None	DO 8	AO 8	DIO 4	DIO 12

- If you select a WI-GTWY-9-xxx as the destination module, you will be asked to select a I/O Register as the destination “output”. Note that the grey-shaded I/O registers have already been allocated.
- Select any intermediate repeater units needed to reach the destination address (entered in order of nearest to furthest repeater). You can either select from the list of configured units or enter the unit address in the “Repeater” box. If no repeaters are required, do not enter anything in the repeater boxes. If only one repeater address is required, enter the address in box 1 and leave the other repeater boxes empty.

Note: Every module must have at least one mapping configured to another module. If no mappings are required (for example, you are only using outputs at a module), then you need to configure a mapping for a spare input to an unused output on another module.

It is possible to configure multiple mappings for an input - each mapping will generate separate transmissions. We recommend that you do not configure multiple mappings to the same output as the output will have the value of the last message that it receives. Each output should have only one mapped input.

It is possible to map a digital input to an analog output - the output will be maximum value when the input is on and minimum value when the input is off. It is also possible to map a analog input to an digital output - the output will be on when the input is equal or greater than 12mA and off when the input is less than 12mA.

For more information on using WI-I/O-EX-1-S-x modules, refer to Section 4.3.8.

Edit existing mappings

To edit an existing mapping, double-click on the mapping line, or select the mapping line and “Edit”.

To delete an existing mapping

To delete a mapping, select the mapping and delete or right-mouse click and select Delete.

Configuring Start-Up Polls

When a unit is first turned on, its outputs will not be set until it receives update messages from other units in the system. To that outputs are set as soon as possible after start-up the unit may be configured to “Poll” any other units with mappings to its outputs.

Select the remote unit to be polled from the unit list, or enter the unit address in the box. If the remote unit communicates via repeaters, select the repeater units or enter the repeater address.

Remember that if more than one remote unit is controlling the local outputs, then more than one start-up poll should be configured.

Configuring Comms Fail Mapping

Each module has a “comms fail” output which may be mapped to a local output. When the comms fail status is active (on) if the module is transmitting a message and does not receive an acknowledgement after five tries. By setting the comms fail status to a local output, you can provide a communications alarm. The local output can be digital or analog - if analog, the output will go to maximum value.

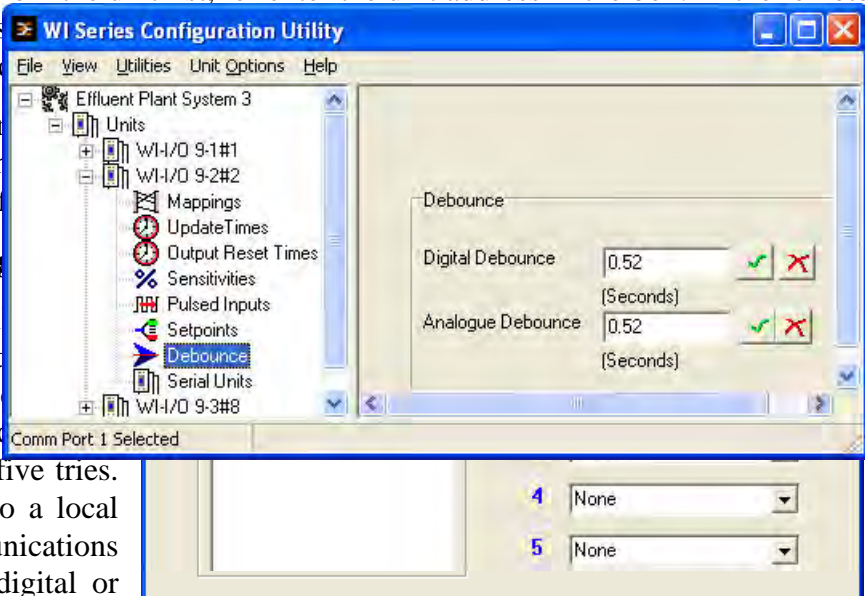

Although communication failure will activate the output, successful comms does not reset the output. You must use the “Reset outputs on comms fail” option (Refer to User Options section).

different remote addresses. You can configure several comms fail mappings to the same output - the output will be active if there is comms fail to any of the remote addresses. Configuring a “Comms Fail Address” of zero causes communication failure to any destination module to be indicated on the selected output.

For example, if “Comms fail to unit 12” is configured to DO1, then the module will set (or activate) DO1 each time communications to unit 12 is not successful. If DO1 has a “Reset output” time of 10 minutes configured for DO1, then DO1 will reset (de-activate) 10 minutes after the last comms fail to unit 12.

Debounce Configuration

Debounce is the time which an input must stay stable before the module decides that a change of state has occurred. If a digital input changes (say 0 → 1) and changes again (1 → 0) in less than the debounce time, then the module will ignore both changes. Debounce may be configured for digital

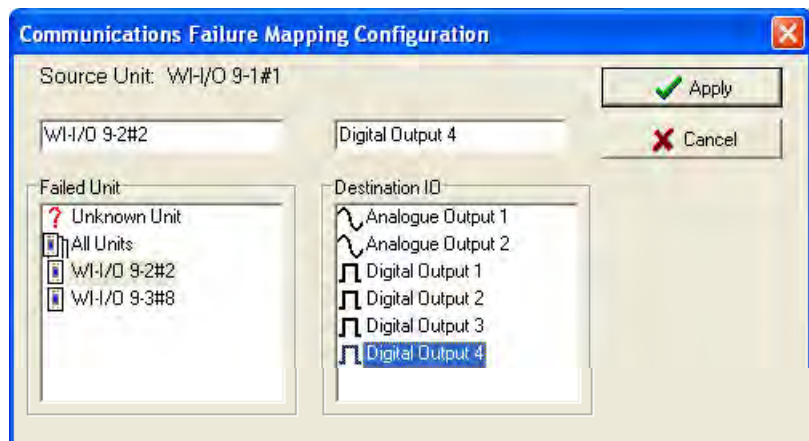

inputs on the -1, -2 and -4 modules (0.5 - 8 seconds) and the analog inputs on the -2 module (0.5 - 8 seconds). The default value of 0.5 seconds is suitable for most applications. In applications where a digital input may turn on and off several times slowly (for example, security switches or float switches) a debounce time of up to 8 seconds may be configured. *The configured debounce time has no affect on pulse inputs.*

Note that the analog debounce is not configurable for the -1 , but is configurable in the -2.

Update Time Configuration

Update messages are sent if a change message has not occurred within the update time period. The update time may be set for each input - both physical and internal inputs.

The default period is 10 minutes for all inputs, except for pulse inputs (1 minute). Short update times should only be used in special circumstances. It is important to remember the principle - “Less radio traffic means better communications”. Frequent updates from multiple units causes congestion of the radio channel, which results in increased communication failures and poorer performance of the system. To change an update time, select “Update Times” on the left-hand menu and double-click the selected input. The update time will be shown in days:hours:minutes:seconds. Change the values in each field. The display also shows the maximum and minimum values. For the -1, -2 and -3 modules, the maximum update time is 16 minutes, however the update time for -4 inputs can be up to 5 days.

If a zero value is entered as an update time, the device will not update.

Changing Multiple Settings

You can change the Update Times of several units at once. For example, if you want to change the update times of all units individually, or you could “block” the update times of all units by clicking the “Edit” button. You only need to enter the change once, and it will be available with the other configurable parameters.

Output Reset Time Configuration

This allows the **Comms Fail Time** to be selected - this is the time for an output to reset if it has not received an update or change message.

Each output on the unit, either analog or digital, may be configured to reset (off or 0mA) when no update transmission has been received for a certain time. This option can be used to ensure that communications failure will not result in loss of control. For example, outputs connected to pumps should be configured to reset on communications failure so that the pump will turn off. The default

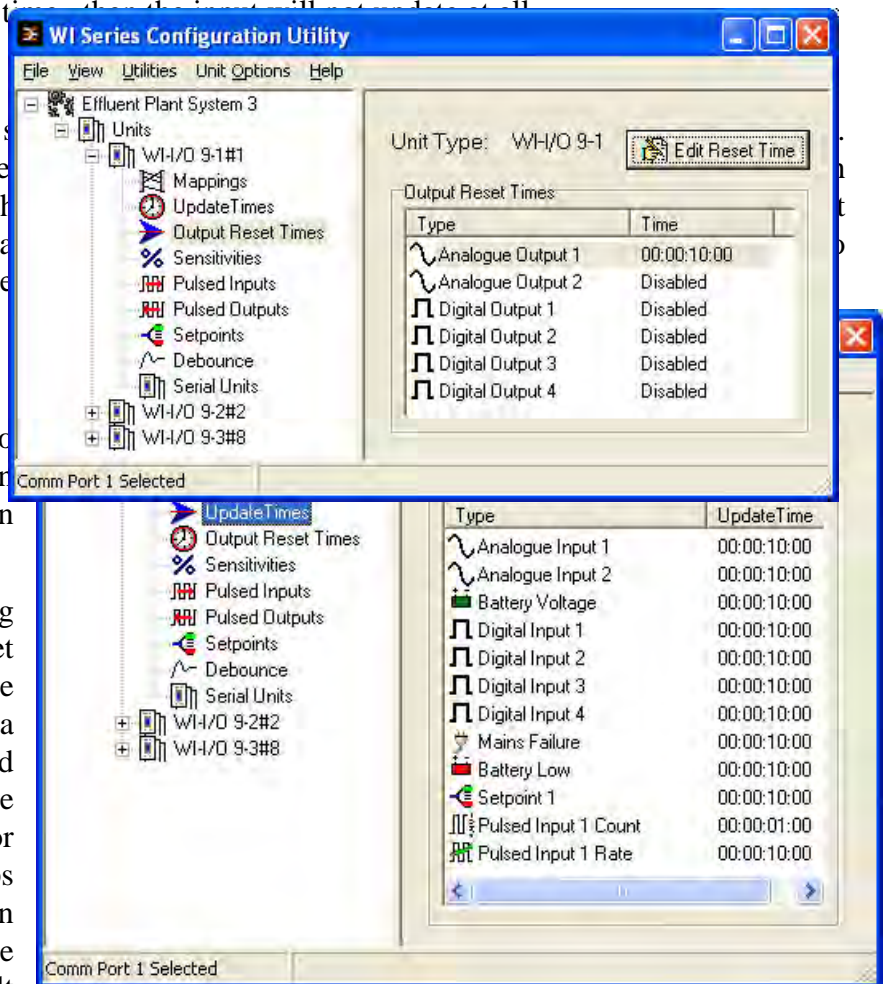

condition is zero (no reset).

If the reset time is less than the update time, then the output will reset when the reset time expires, and then set again when the update message is received. We recommend that the reset time be a little more than twice the update time.

To set an output reset time, select “Output Reset Times” on the left-hand menu and double-click the selected input. The update time will be shown in days:hours:minutes:seconds. Change the values in each field. The display also shows the maximum and minimum values.

Analog Sensitivity Configuration

The analog sensitivity is the change required in an analog input before a “Change Of State” is detected, and the new analog value is transmitted. For input signals which vary widely over a short period of time or have a normal oscillation, the analog sensitivity should be set to an appropriately large value. This ensures that many change messages are not transmitted in too short a time. This will result in channel congestion, as described in the preceding section.

To change an analog sensitivity, select “Sensitivities” on the left-hand menu and double-click the selected input. The sensitivity for physical inputs is shown in mA and internal input is shown as %.

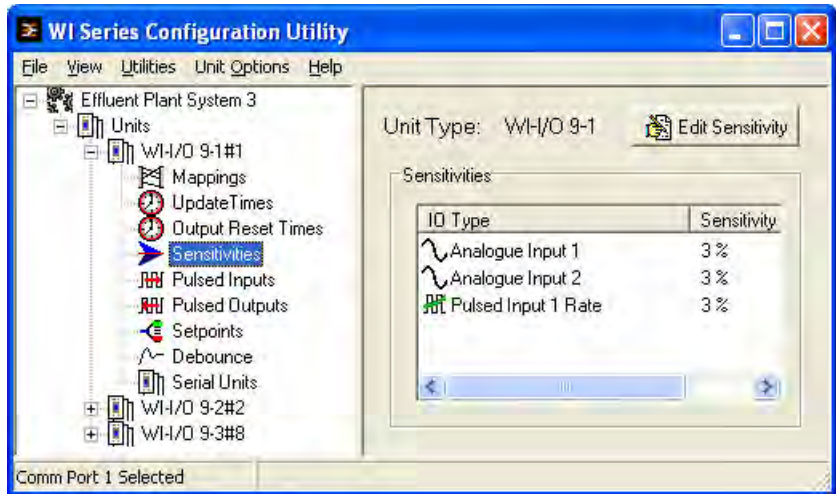

SetPoint Configuration

Setpoints allow a remote digital output to be turned on and off depending on the value of an analog input. The “set-point status” internal input must be mapped to an output for this option to have effect.

When the AI is less than the Low Set-point (LSP), the set-point status will be active (on, “1”) - when the AI is more than the High Set Point (HSP), the set-point status will be reset (off, “0”). Note that the High Set Point (HSP) must always be higher than the Low Set Point (LSP). For the -1 module, only AI1 has set-point values. For -2 modules, the first four analog inputs (AI 1 – 4) have set-points.

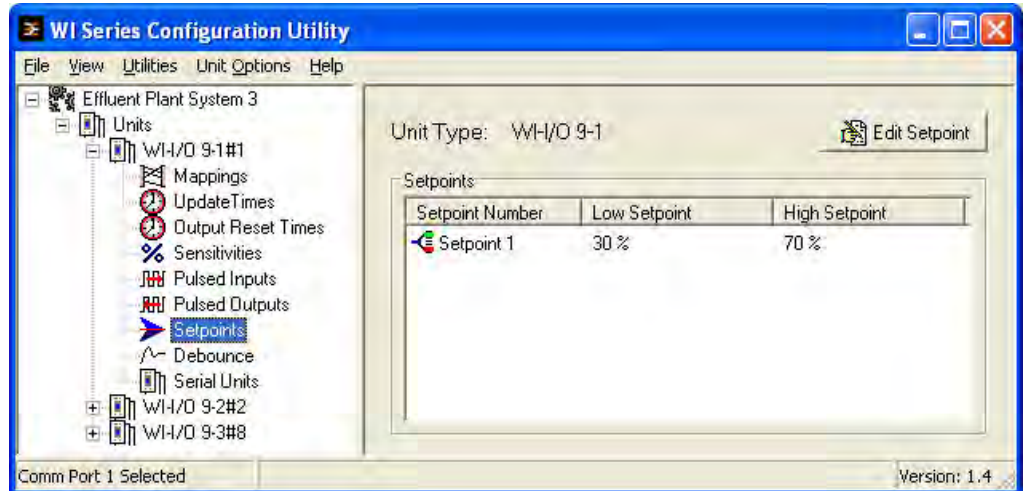

Debounce time operates on the set-point status in the same way as digital inputs.

To change a setpoint values, select “SetPoints” on the left-hand menu and double-click the selected Setpoint Status.

Pulse Input Count Configuration

PI1 of the -2 and -4 modules normally count up to 100Hz (as for the other PI's), however can be configured to count up to 1000Hz. This configuration actually divides the input count by 10 - each count in the PI1 register is then equivalent to 10 input pulses. If PI1 is mapped to a PO, then the maximum output pulse rate is 100Hz, however each output pulse is equivalent to 10 input pulses.

To configure the “divide by 10” feature, select “Pulse Inputs” on the left-hand menu and select the “Count” page - double-click “Pulse Input 1 Count” and enable “divide by 10” counting.

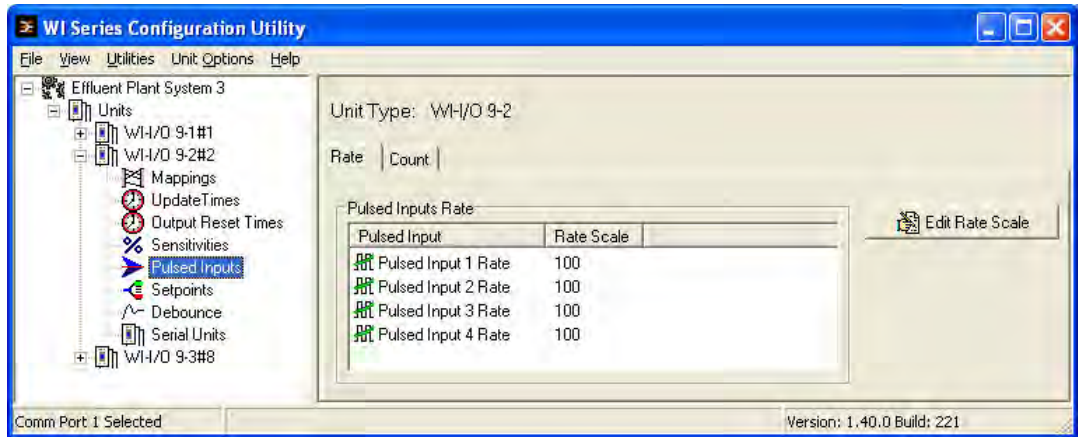

Pulse Input Rate Scale Configuration

When a pulse rate is mapped to an analog output, the rate must be scaled to the 4-20mA output. The pulse rate scale is the rate (in Hz) corresponding 20 mA.

To configure the pulse rate scale, select “Pulse Inputs” on the left-hand menu and select the “Rate” page - double-click the pulse input rate and enter the scale value.

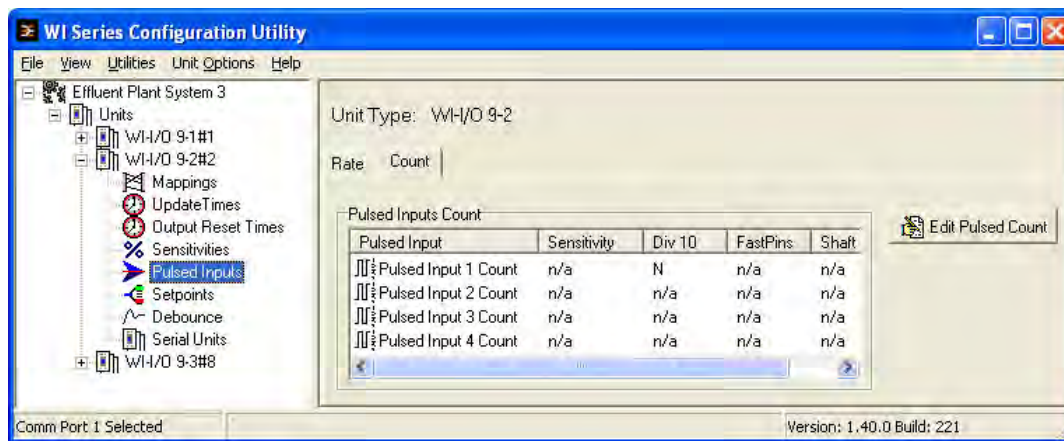

Pulse Output Update Time Configuration

The pulse output update time is the time period over which pulses are output after a PI update is received. It should be configured to correspond to the pulse input update time for the corresponding pulse input. This ensures that the pulse output rate matches as closely as possible the pulse input rate which it is reflecting.

For example, if the PI update time is 1 minute, then the PO update time should also be 1 minute. If the PI update time is changed, then the PO update time at the remote module should be also changed.

The PO will still operate if the time is not changed, however pulses may be output faster or slower than the input pulses.

To configure the pulse output time, select “Pulse Outputs” on the left-hand menu and select the “Pulsed Output Time” page - double-click the pulse output and enter the new time.

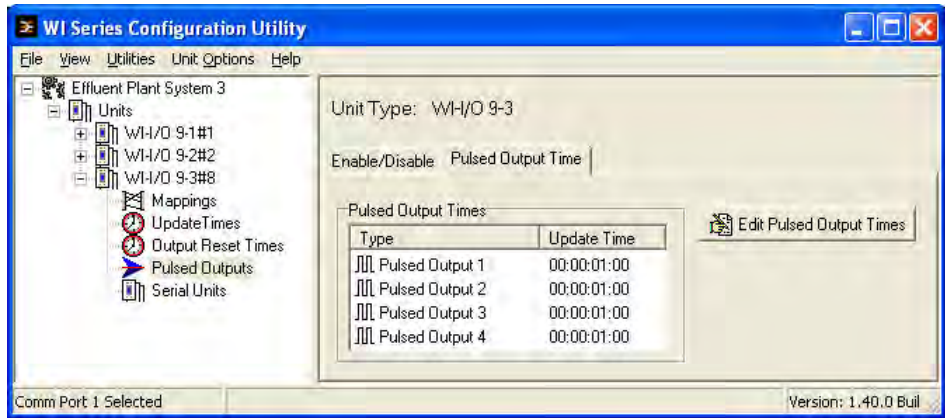

Pulse Output Enable

The PO's for the -2 and -4 modules are also DO1-4. To use as pulse outputs, you need to enable them as pulse outputs.

To enable pulse outputs, select “Pulse Outputs” on the left-hand menu and select the “Enable/Disable” page - double-click the pulse output to enable.

Compiling a System

When you have finished configuring the modules, you should compile the system. The compile function scans the

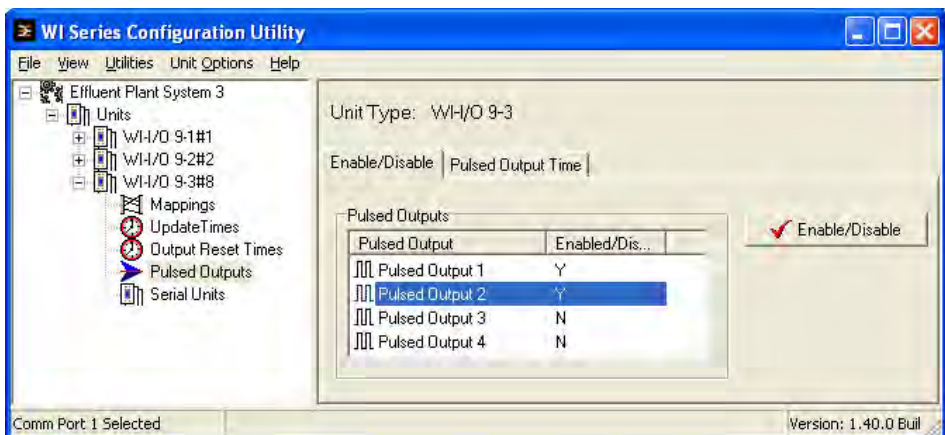

configuration and reports any detected errors. To compile the system, select “Compile System” from the “Utilities” menu. Select the “Compile” button. The system will compile - the display will show if there are any compile errors or warnings.

4.3.3 Programming Configurations to Modules

To program a module :

- Connect the cable from the PC's serial port to the module serial port (see 2.4.10 for cable connections)
- From the Utilities menu, select "Serial Port Setup"
- Select the appropriate serial port (COM1 - COM4)
- Select the unit to be configured from the left-hand menu
- Double-click "Program Unit".

Each module will need to be programmed individually.

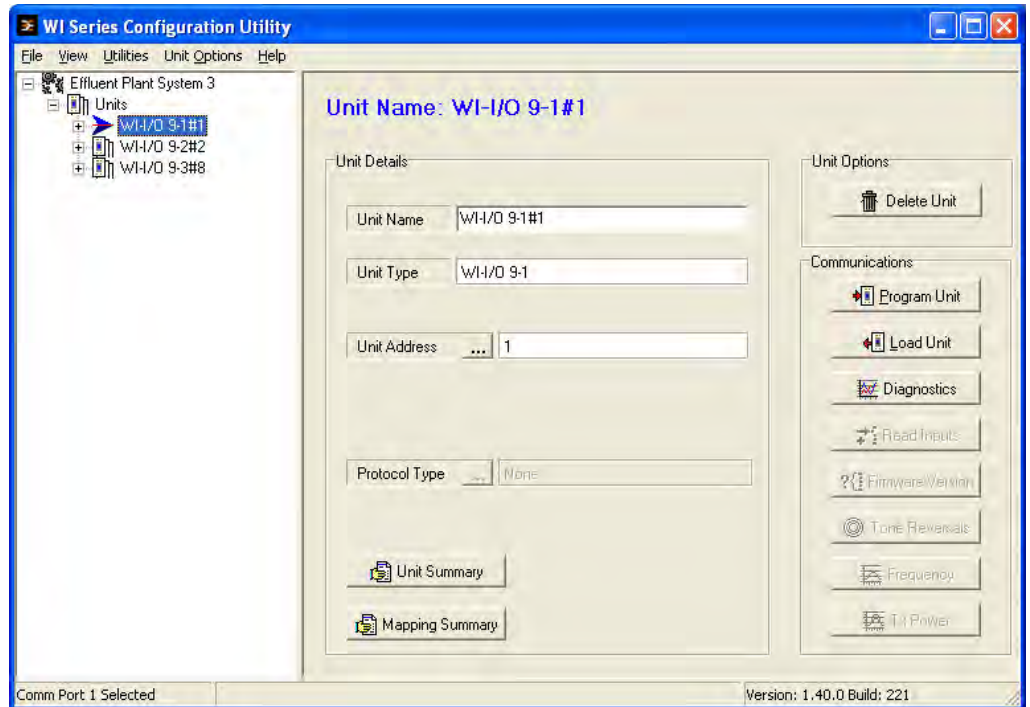

4.3.4 Loading Configuration from a Module

Care should be taken when loading a configuration from a module. It is easy to lose the system address and unit address. We suggest that you first view the system address and unit address - you can do this via the "Unit Options" menu. Note these addresses before loading the configuration.

When you upload the configuration, the program will check if you want to load the addresses from the module. **If you do not, then the system address and unit address will change.**

You are able to upload the configuration from a module into a new "project", to view the configuration and modify it. Note that as the "project" will not have the details of the other modules in the system, the other modules and outputs will be shown as unit addresses and output numbers. Don't forget to download the configuration into the module after you modify it.

If security has been enabled for the system, please read section 4.3.7.

If you are adding additional mappings to a WI-I/O 9-C or WI-GTWY-9-xxx module, then you need to change the archived configuration files first so you can download the modified configuration details into the WI-I/O 9-C or WI-GTWY-9-xxx.

4.3.5 Modifying and Archiving Configuration Files

As you build a system configuration, it is automatically saved in the “Project” directory. We recommend that all system additions and changes be made to the archived configuration files first, and then downloaded to the module/s. This ensures that the archived files are always maintained and accurate. If you modify the configuration of a module by uploading and then downloading, then the module configuration will be different than the archived files.

If you lose the configuration files for a system, then you can rebuild the configuration by uploading the configuration file from every module in the system.

4.3.6 Print Options

You can obtain a print-out of each module configuration. On each unit display, there are “Unit Summary” and “Mapping Summary” windows. Each of these will display a printable information page about that module. The Unit Summary page will display the user options configured, and the Mapping Summary will display the mappings entered for that unit.

The printer may be selected from the Printer Setup option in the File menu.

4.3.7 Security

There are two security features available. You can enter a password to protect the configuration files, and you can enable security encryption of the radio transmissions.

The password can be between 6 and 256 characters. The password is case sensitive and any ASCII characters can be used. If you have entered a password, then this password will need to be entered if the configuration is to be changed later. You can view the configuration, but you will not be able to make any changes. You are able to change the password from the “Utilities” menu. If unauthorised access to the files is a concern, we recommend that you change the password regularly or whenever there is a change of staff.

Security Encryption is an additional level of security. The security option uses an 8-character security key to provide 64-bit data encryption of the radio messages. All modules in the same system will be configured with the same security key used to encrypt and decrypt the messages. This feature is available for modules with serial numbers with the middle three numbers greater than 210 - that is xxxx210xxxx, or xxxx220xxxx etc. If you are adding modules to an old system which does not have the security encryption feature, then you cannot use security encryption on the new modules.

Note that the security key is different than the password.

- To enable the security encryption, select the “Enable Security” box on the project display. An 8-character security key is entered and you will be prompted to enter the security code a second time to confirm. The security key can be any characters or numbers. Characters are case sensitive. The security key will never be displayed.
- If you do not enable security, there will be no data encryption of the radio messages. This is the default setting.
- If a security key has been entered, this key is downloaded into each module as part of the configuration download process. You can download another configuration at any time - if the security key is different, or if there is no security key in the new configuration, the old key will be

over-written.

- You can change the security key in the configuration files simply by entering a new security key in the security key window. You will be prompted to confirm the new security key. If the configuration files are password-protected, you will be asked for the password. Note that if you change the security key, it will not match the security key previously loaded into existing modules.
- If you want to change a configuration, we recommend that you change the archived configuration, and then download the configuration onto the module. The archived configuration already has the valid security key.
- If you lose the archived configuration, you can upload the configuration from a module, but you cannot upload a security key. That is, you can upload the module configuration, view it, change it - but if you don't know the original security key, the old key will be over-written when you download the new configuration. This module will no longer communicate with other modules in the system as the security key is different.

The security options provide security against a “hacker” in the following way:

- ❑ A hacker cannot listen-in to radio messages without the security key to decrypt the radio messages. Similarly, a hacker cannot force outputs by transmitting a radio message to a module without the security key.
- ❑ A hacker cannot access the security key from an installed module or from the configuration files.
- ❑ The archived configuration files cannot be changed, downloaded or uploaded without the password.

Warning!!

These security options provide a high level of security, but no data-security system can provide “100% protection”. But it does make it very difficult for someone to interfere with the WI-I/O 9-x system - difficult to the point where there would be many easier alternate ways to cause malicious damage.

The password must be kept in a secure place. Security procedures need to be adopted. If staff with access to the password leaves your organization, we recommend that the password be changed.

We recommend that you use a random 8-character string for the security key and that you do not record the key. It is not necessary to know what the security key is. The key will be recorded in the archived configuration files, and therefore the configuration files should be held in a secure place and backed up.

The security key does not prevent a hacker uploading a configuration from a module and downloading with a new security key. This module will no longer operate with other modules in the system. To prevent this, unauthorized access to modules must be prevented.

If you lose the configuration files, you can regenerate these by uploading the configuration from every module in the system into a new project with a new security key. After uploading each module, download the configuration with the new security key.

If you wish to change the security key, simply enter a new key in the configuration program, and download the new configuration to all modules in the system.

4.3.8 Using WI-I/O-EX-1-S-x Modules

WI-I/O-EX-1-S-x modules can be used by themselves, as “line telemetry” or “wired I/O”, or they can be used as I/O expansion for WI-I/O 9-x modules. As the WI-I/O-EX-1-S-x modules are connected by RS485, the WI-I/O-EX-1-S-x modules can be separated from the WI-I/O 9 modules by some distance. There can be up to 32 addresses on the one RS485 multi-drop link. Note that each –3 and –4 module takes up 2 addresses. For example, you could have up to 32 modules sharing a multi-drop link if they are all –1 or –2 modules - if they are all –3 or –4, then you could only have 16 modules on the link.

WI-I/O-EX-1-S-x modules are configured with unit addresses in the range 96 – 127.

Example 1 - Mapping to another WI-I/O-EX-1-S-x module on the same link.

The I/O mapping is done in the same way as for WI-I/O 9-x modules.

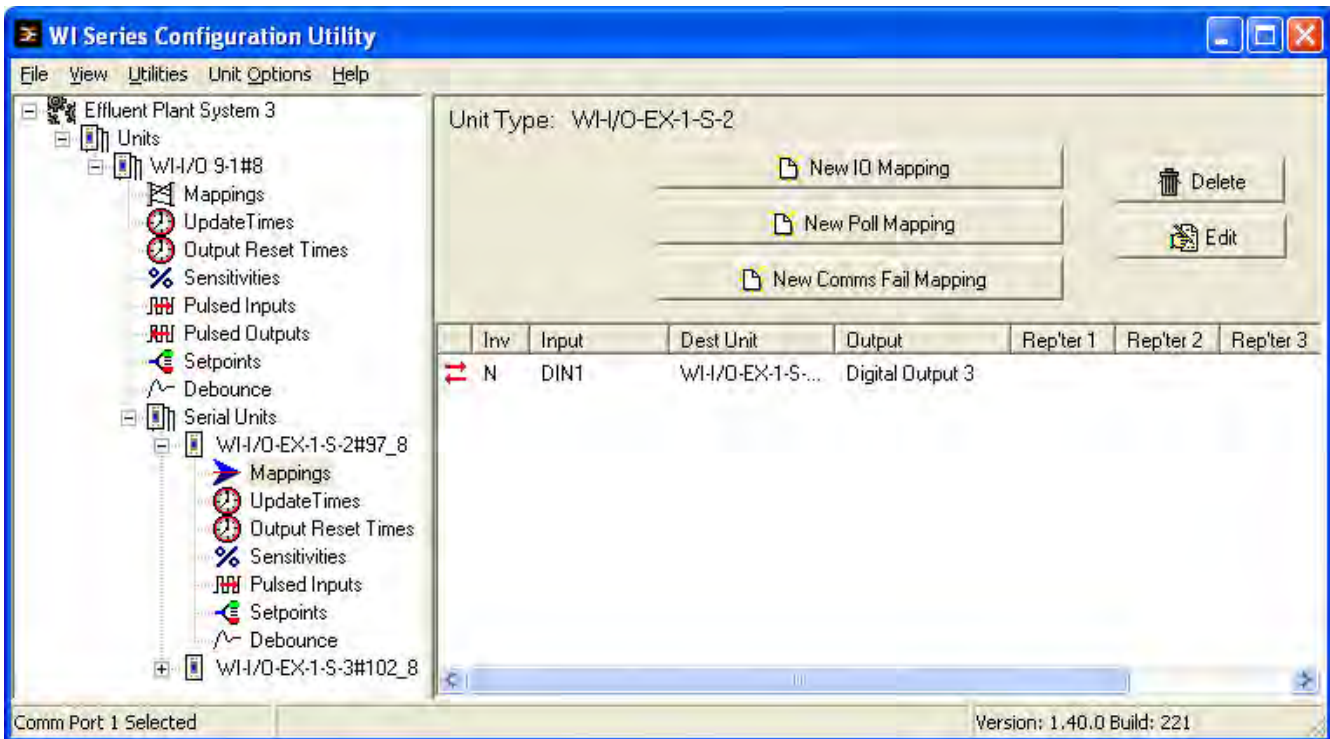

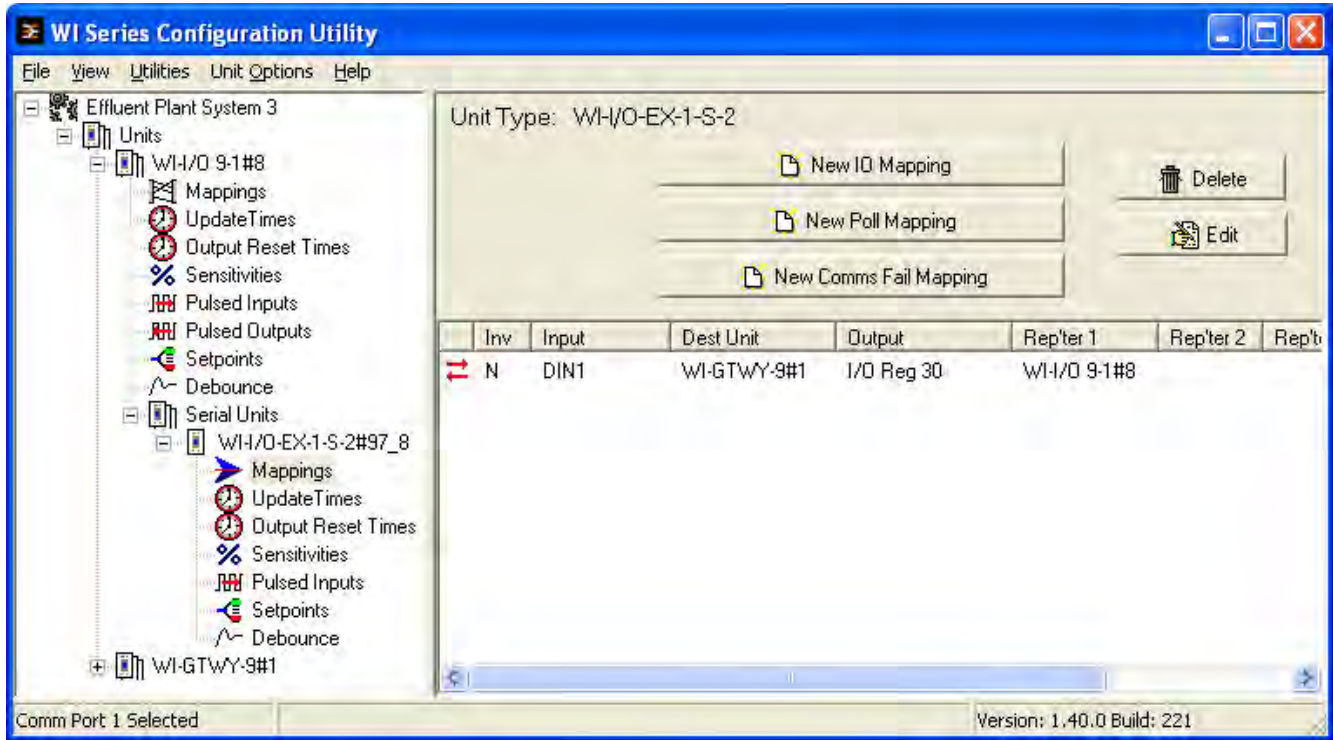

Example 2 - Mapping to a remote WI-I/O 9-x.

In this example, a WI-I/O-EX-1-S-x-2 is connected to WI-I/O 9-1#8. DI1 is mapped to a remote WI-GTWY-9-MD1 module. The WI-I/O 9-x that is connected to the WI-I/O-EX-1-S-x module acts as a repeater - a serial-to-radio repeater.

When DI1 changes, the WI-I/O-EX-1-S-x will send a message via the serial link to WI-I/O 9-1#8.

Example 3 - Mapping to another WI-I/O-EX-1-S-x which is connected to a different WI-I/O 9-x

In this example, both WI-I/O 9-x modules act as repeaters. The first is a “serial-to-radio” repeater and the second is a “radio-to-serial” repeater.

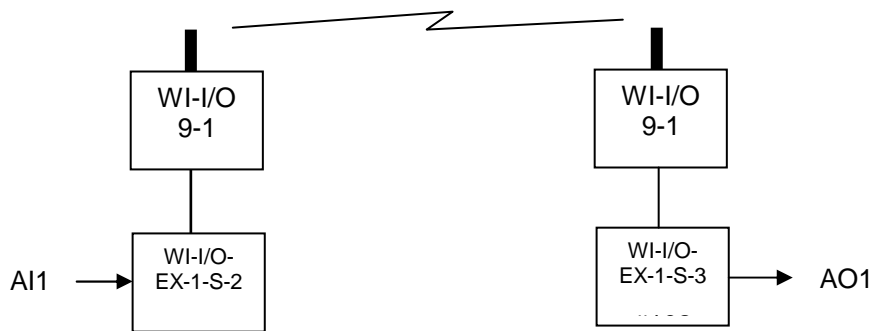
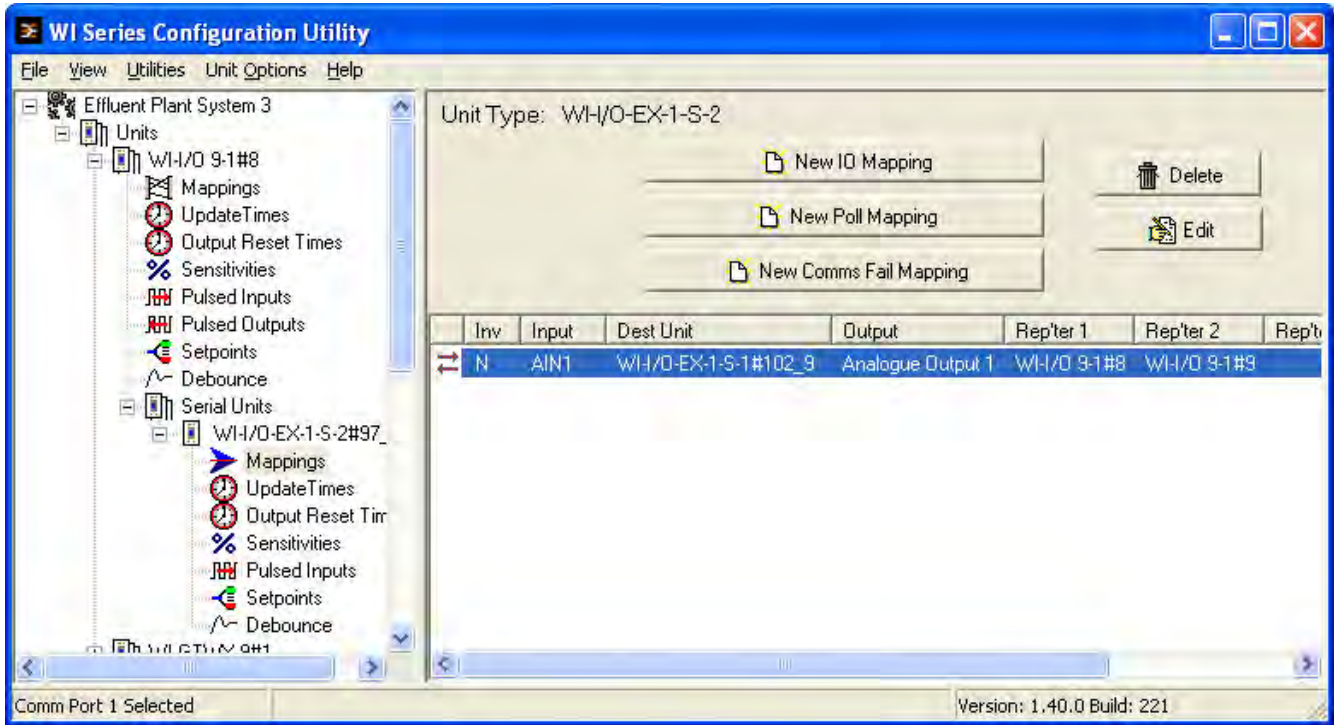

Chapter Five

SPECIFICATIONS

General		
WI-I/O 9-x Radio standards	FCC Part 15A, Part 15.247	902 – 928 MHz, 1W
Housing	130 x 185 x 60mm DIN rail mount Refer section 5.1 for dimensioned drawing	Powder-coated, extruded aluminium
Terminal blocks	Removable	Suitable for 2.5 mm ² conductors
LED indication	Power supply, OK operation, digital I/O, RX and TX	
Operating Temperature	WI-I/O 9-x, WI-I/O-EX-1-S-x	-40 to 60 degrees C / -40 to 140 degrees F -30 to 60 degrees C / -20 to 140 degrees F
Humidity	0 – 99% RH non-condensing	
Power Supply		
Battery supply	11.3 - 15.0 VDC	
AC supply	12 - 24 VAC, 50/60 Hz	Overvoltage protected
DC supply	15 - 30 VDC	Overvoltage and reverse voltage protected > 17VDC required for charging battery
Battery Charging circuit	Included	for 1.2-12 AHr sealed lead acid battery
Solar regulator	Included	Direct connection of solar panel (up to 30W) and solar battery (100 Ahr)
Current Drain at 12VDC	85 mA quiescent for ‘U’ 45 mA quiescent for ‘S’	+ 10 mA/active digital input + 25 mA/active digital output + 2 x analog I/O loop (mA)
Radio transmitter inrush	WI-I/O 9-x	350mA @ 13.8VDC; 250mA @ 24VDC 450mA @ 13.8VDC (0.5W) 600mA @ 13.8VDC (1W) 800mA @ 13.8VDC (2W) 1.25A @ 13.8VDC (5W)
Analog loop supply	Included, except -4	24V DC 150 mA
Mains fail status	Monitored	Can be transmitted to remote modules
Battery voltage	Monitored	As above

Radio Transceiver (WI-I/O 9-x)		
Spread spectrum	Frequency hopping	
Frequency	USA/Canada	902 – 928 MHz
	Australia	915 – 928 MHz
	New Zealand	922 – 928 MHz
Transmission Power	1W	
Signal detect / RSSI	-120 to –50 dBm	
Expected line-of-sight range (subject to local conditions)	20 miles + @ 4W ERP 15 km + @ 1W ERP depending on local conditions	USA / Canada Australia / New Zealand Range may be extended by up to 5 intermediate modules as repeaters
Antenna Connector	Female SMA coaxial	
Data transmission rate	19200 baud	
Serial Ports		
RS232 Port	DB9 female DCE	9600 baud, no parity, 8 data bits, 1 stop bit
RS485 Port	2 pin terminal block	9600 baud, no parity, 8 data bits, 1 stop bit, Typical distance 1 mile / 2km
Data transmission	On change-of-state + integrity update	Update time configurable
Protocol - serial - radio	asynchronous ARQ, with 16 bit CRC synchronous ARQ	Automatic acknowledgements with up to 4 retries
Communications fail status	May be mapped to local or remote output	Resetting of outputs on comms fail configurable
Inputs and Outputs		
Digital Inputs	WI-I/O 9-x_WI-I/O-EX-1- S-1 Four WI-I/O 9-x_WI-I/O-EX-1- S-2 Four WI-I/O 9-x_WI-I/O-EX-1- S-3 None	Opto-isolated (5000V)inputs, suitable for voltage free contacts or NPN transistor, contact wetting current 5mA, input debounce 0.5 second For –4 modules, as above, but with 3000V surge protection instead of opto-isolation

	WI-I/O 9-x_WI-I/O-EX-1-S-4 Four plus 12 selectable I/O	
Digital Outputs	WI-I/O 9-1_WI-I/O-EX-1-S-1 Four	Relay output contacts, normally open, AC 5A 50V DC 2A 30V, 5A 20V
Digital Outputs	WI-I/O 9-2_WI-I/O-EX-1-S-2 One	
	WI-I/O 9-3_WI-I/O-EX-1-S-3 Eight WI-I/O 9-4_WI-I/O-EX-1-S-4 Four plus 12 selectable I/O	
Pulse Inputs	WI-I/O 9-1_WI-I/O-EX-1-S-1 One	Uses DI1. Max rate 100Hz, min. off-time 5msec. Uses DI1-4. Max rate of DI1 is 1000Hz, min. off-time 0.5msec
	WI-I/O 9-2_WI-I/O-EX-1-S-2 Four	Max rate of DI2-4 is 100Hz, min. off-time 5msec.
	WI-I/O 9-3_WI-I/O-EX-1-S-3 None	
	WI-I/O 9-4_WI-I/O-EX-1-S-4 Four	
Pulse Output	WI-I/O 9-1_WI-I/O-EX-1-S-1 One	FET output, 30 VDC 500mA max Max rate for WI-I/O-EX-11 is 100 Hz. Max rate for WI-I/O-EX-1-S-13 is 1000 Hz. Pulse signal recreated, pulse rate avail. on analog output, (scaling configurable). Divide-by-10 available for 1000Hz inputs.
	WI-I/O 9-2_WI-I/O-EX-1-S-2 None	
	WI-I/O 9-3_WI-I/O-EX-1-S-3 Four	
	WI-I/O 9-4_WI-I/O-EX-1-S-4 Four	
Analog Inputs	“floating” differential input, common mode voltage -0.5V to 27V	24 VDC for powering external loops provided, 150 mA max. Digital filter time constant 1 second (config.)
	WI-I/O 9-1_WI-I/O-EX-1-S-1	Resolution 15 bit, Accuracy 0.1%
	Two 4-20 mA	Resolution 12 bit, Accuracy 0.1%
	WI-I/O 9-2_WI-I/O-EX-1-S-2	
	Six 0-20mA	
Analog Input Setpoints	WI-I/O 9-1_WI-I/O-EX-1-	Configurable high & low set-points, allowing

	S-1 AI 1 only WI-I/O 9-2_WI-I/O-EX-1-S-2 AI 1-4	set/reset of remote digital outputs
Analog Outputs	current sink to common WI-I/O 9-1_WI-I/O-EX-1-S-1 Two 4-20mA WI-I/O 9-3_WI-I/O-EX-1-S-3 Eight 0-20mA	max loop voltage 27V, Resolution 15 bit, Accuracy 0.1% Resolution 12 bit, Accuracy 0.1%
System Parameters		
Network Configurations	Communications via radio or RS485 or network of both	Up to 95 radio units with up to 32 serial units off each radio unit
User Configuration	Any input to any output in system	RS232 PC or laptop
Diagnostics		
On board diagnostics	Automatic check on start-up Via RS232 terminal or laptop	Input status Output test Incoming radio signal level Simple radio path testing

Chapter Six

TROUBLESHOOTING

6.1

Diagnostics Chart

INDICATOR	CONDITION	MEANING
OK LED OFF	Continuously	<ul style="list-style-type: none">• Battery Voltage low• CPU failure• +24V supply failure/overload
OK LED ON	Continuously	<ul style="list-style-type: none">• Normal Operation
PWR LED ON	Continuously	<ul style="list-style-type: none">• Supply available from SUP1/SUP2• Supply available from solar panel
TX LED ON	Flashes briefly	<ul style="list-style-type: none">• Radio transmitting
RX LED ON	Flashes briefly	<ul style="list-style-type: none">• Radio Receiving• Serial port communicating
RX LED ON	Flashes continuously	<ul style="list-style-type: none">• Module in Configuration Mode
RX LED ON	Continuously	<ul style="list-style-type: none">• Test Button press in Configuration Mode
No transmission on change of state		<ul style="list-style-type: none">• Unit not configured correctly - re-configure and check operation

The green OK LED on the front panel indicates correct operation of the unit. This LED extinguishes on failure as described above. When the OK LED extinguishes shutdown state is indicated. In this state, all digital outputs turn OFF and the +24V supply turns off.

On processor failure, or on failure during start-up diagnostics, the unit shuts down, and remains in shutdown until the fault is rectified. The unit also shuts down if the battery voltage falls below 10.8 volts. This is a protection feature designed to protect the battery from deep discharge in case of extended period without supply voltage.

Note: During diagnostic testing, it is likely that the module will reset and restart. This will affect the output signals.

6.2

Self Test Functions

6.2.1 Input to Output Reflection (WI-I/O 9-1_WI-I/O-EX-1-S-1 only)

The unit will require re-configuration after SELF TEST. Ensure you know the required operational configuration including system and unit addresses so that the network can be restored after testing.

Remove the cover in the front panel, and set the DIP switches as shown below. Hold down the red button for five seconds, or until the Rx LED glows yellow, release the Red button (the Rx LED now flashes), then press and release the Red button (the flashing Rx LED extinguishes).

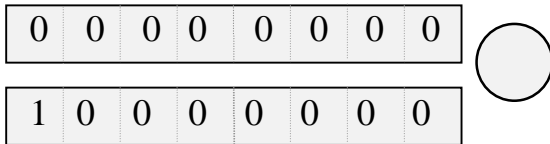

Input signals may now be connected to the input terminals of the module. If the module is operating correctly, then the input signals will be reflected to the corresponding output on the same module. For example, if DI 1 is connected to common - i.e. the first digital input is turned "ON" - then DO 1 will activate, if the module is functional. Similarly, if a 12mA signal is connected to AI 2, then a 12mA signal should be able to be measured from AO 2, if the module is functioning correctly.

If a module does not pass its self test function, then it should be returned to an authorised service agent for attention

6.2.2 Radio Testing using Tone Reversals (WI-I/O 9-x modules only)

This function allows the unit to be configured to continuously transmit a sequence of alternate zeros and ones on the radio. This function provides the facility to check VSWR of antennas during installation, as well as checking the fade margin of the path between two units (see below - received signal strength indication).

The tone reversals function is initiated by setting all of the DIL switches to ON, and holding down the red button for approximately 5 seconds(until the RX LED lights continuously). On releasing the button, the RX LED will flash continuously, and the TX LED will light, indicating that the radio transmitter is on.

To finish the test, push the red button again or re-power the module.

6.2.3 Diagnostics menu

To aid in the checking and set-up of the module, a user friendly menu provides access to diagnostic functions. Use of the diagnostics menu does not affect module configuration.

The diagnostics functions can be accessed from the E Series Config software - the same software package used to configure the modules. Connect the laptop or PC to the module using a configuration RS232 cable.

Either open the archived project containing the module, or start a New Project and select “Load a New Unit” - select the correct type of module. After the unit has loaded, select the Diagnostics box.

A “Terminal” screen will appear. Select the “Terminal” box.

Connect the module (ensure the RS485 port is disconnected first) to the PC using the same serial cable

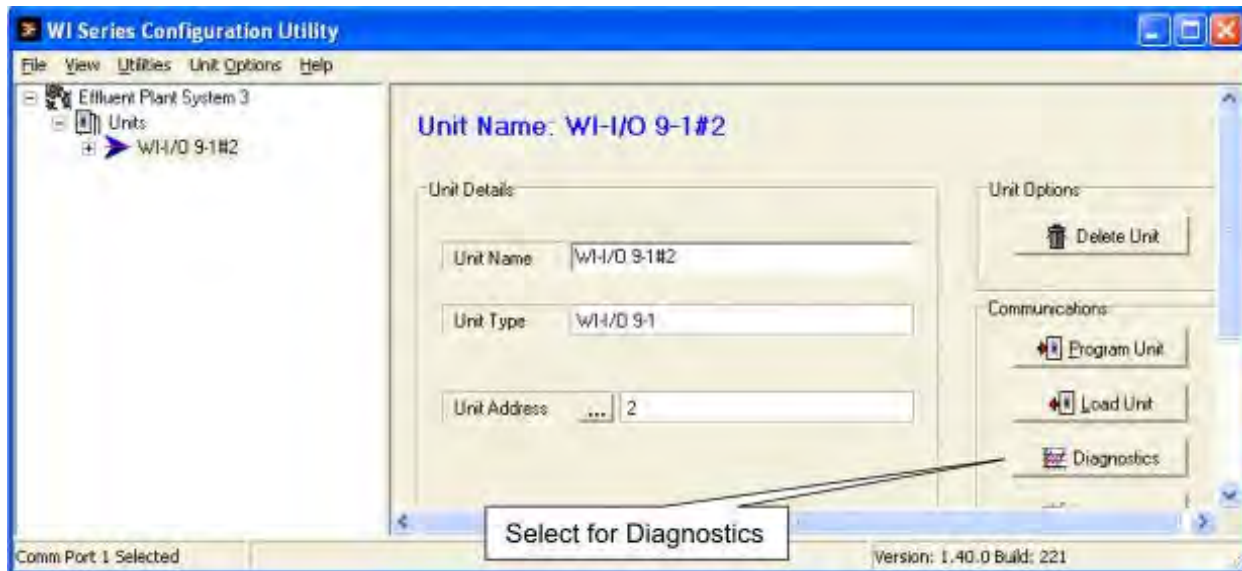

used for configuration.

The diagnostics menu is accessed by removing the blue “plug” from the front of the module and setting all switches to ‘0’ or “Open”, and holding down the red button for approximately 5 seconds, until the RX LED lights continuously. One of the following menus will be displayed on the terminal :

- | | | |
|------------|----|-----|
| WI-I/O 9-1 | e) | DO2 |
| a) Ins | f) | DO3 |
| b) Tones | g) | DO4 |
| c) Comms | h) | AO1 |
| d) DO1 | | |

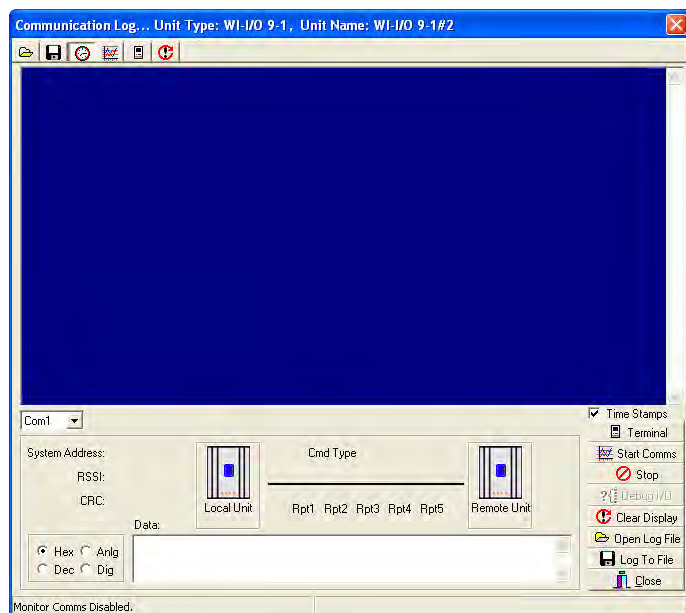

	AO2	WI-I/O 9-2	WI-I/O 9-3	WI-I/O 9-4
i)	AO2			
j)	Switch	a) Digital Ins	a) Ins	a) D Ins
k)	Signal	b) Analog Ins	b) Tones	b) A Ins
>		c) Tones	c) Comms	c) Tones
		d) Comms	d) DO1	d) Comms
		e) DO1	e) DO2	e) DO1
		f) Switch	f) DO3	f) DO2
		g) Signal	g) DO4	g) DO3
		>	h) DO5	h) DO4
			i) DO6	i) DIO1
			j) DO7	j) DIO2
			k) DO8	k) DIO3
			l) AO1	l) DIO4
			m) AO2	m) DIO5
			n) AO3	n) DIO6
			o) AO4	o) DIO7
			p) AO5	p) DIO8
			q) AO6	q) DIO9
			r) AO7	r) DIO10
			s) AO8	s) DIO11
			t) Switch	t) DIO12
			u) Signal	u) Signal
			>	>

Choose an item from the menu by entering the letter before that item. For example, to select the "Signal" function from the WI-I/O-EX-1-S-11 Menu, enter :- k

During the diagnostics session, if you press Enter or Space while the menu is displayed, the module will restart in normal operating mode. To re-enter diagnostics mode, hold the red button for 5 seconds etc.

After the diagnostics session is over, force the module to restart, then select "Stop Terminal", then "Close".

Inputs

This option provides a dynamic display of the status of all of the inputs in the WI-I/O 9-x, both internal and external.

WI-I/O 9-1/WI-I/O-EX-1-S-1 Modules

```
1234MLS   P CNT AI1  AI2  PRATE VBATT
0101001   00F6 C000 4000 8000 9C00
```

The first 7 values (1234MLS) each represent a single digital input. A '1' indicates that that input is ON, and a '0' indicates that the corresponding input is OFF. "1234" represents the four physical digital

inputs, DI1 to DI4. "M" is the mains fail status ('1' for mains fail, '0' for mains OK). "L" is the battery low volts status ('1' for low volts '0' for OK). "S" is the set-point status.

P CNT, AI1, AI2, P RATE, and VBATT each represent 16 bit values, displayed as four hexadecimal digits.

P CNT is the current value of the pulsed input counter. This value should increment each time 'DI 1' turns from OFF to ON. P RATE displays the current pulse rate at DI1. This value is scaled according to the MAXRATE value configured (0 Hertz is displayed as 4000, and the maximum rate is displayed as C000).

AI1 and AI2 represent the value for the two analog inputs. Full scale input (20 mA) is displayed as C000, 4mA is displayed as 4000, and 0ma is displayed as 2000. Analog inputs are filtered digitally with a time constant of 1 second, so a sudden change in the analog input current will result in a slower change in displayed analog value, finally settling at the new value.

A guide to translate the displayed value to the analog input current is provided below.

Add together the figures corresponding to each digit in each position to determine the current (mA) e.g. displayed value 3456 = 2.000+0.500+0.039+0.003 = 2.542mA				
Digit	Leftmost position	Next position	Next position	Rightmost position
0	-	0.000	0.000	0.000
1	-	0.125	0.008	0.000
2	0.000	0.250	0.016	0.001
3	2.000	0.375	0.023	0.001
4	4.000	0.500	0.031	0.002
5	6.000	0.625	0.039	0.002
6	8.000	0.750	0.047	0.003
7	10.000	0.875	0.055	0.003
8	12.000	1.000	0.063	0.004
9	14.000	1.125	0.070	0.004
A	16.000	1.250	0.078	0.005
B	18.000	1.375	0.086	0.005
C	20.000	1.500	0.094	0.006
D	22.000	1.625	0.102	0.006
E	-	1.750	0.109	0.007
F	-	1.875	0.117	0.007

VBATT is the current internally derived battery voltage. 4000 corresponds to 8 Volts, C000 represents 16 volts. A quicker method is use the calculation :

Battery voltage (volts) = $\frac{1}{2} I + 6$, where I is the mA value determined from the above table using VBATT. For example, a value of VBATT of A000 gives an I value of 16mA from the above table. The battery voltage corresponding to this is 14V (or $\frac{1}{2} \times 16 + 6$).

WI-I/O 9-2_WI-I/O-EX-1-S-2 Modules

Digital Inputs

DIN	SETPNT	PULSED			
1234	MSL123456	PIN1	PIN2	PIN3	PIN4
0000	100111111	0000	0000	0000	0000

Analog Inputs

VBAT	PR1	PR2	PR3	PR4	AI1	AI2	AI3	AI4	AI5	AI6
8138	4000	4000	4000	4000	0D3A	0CD2	0CC7	0CC7	0CD4	0CC7

WI-I/O 9-3_WI-I/O-EX-1-S-3 Modules

ML	VBAT	VSLR
00	9FA2	0000

WI-I/O 9-4_WI-I/O-EX-1-S-4 Modules

Digital Inputs

DIN	DIO	PULSED				
1234	123456789ABC	MLS	PIN1	PIN2	PIN3	PIN4
1001	010101010	001 101	0001	0001	0001	0001

Analog Inputs

VBAT	PR1	PR2	PR3	PR4
8DBE	0000	0000	0000	0000

Tones (WI-I/O 9-x modules only)

This provides the same function as described above in 6.2.2. Tone Reversals. This function may be used to check VSWR of antennas, and may be used in conjunction with the Signal option (described below) to check the path between two units.

Comms

This function allows monitoring of all messages transmitted and received over the radio. A better comms display function is available using the “Comms Logging” feature in the configuration software - refer to section 6.2.4.

Transmitted messages are displayed starting in the leftmost column of the display. Received messages are displayed with the received signal strength preceding the message. The first four hexadecimal digits are the system address attached to the message, and must match for units to communicate successfully.

The received signal strength is in negative dBm - the lower the measurement, the stronger the radio signal. A measurement larger than 95 indicates a weak radio signal.

Example:

>c

Comms

TX: 01FA8106008005C6727D44 Command message transmitted by this unit.
84 01FA8186C6E0E3 Acknowledge received from remote.
81 01FA860100800100009286 Message received from remote unit.
TX: 01FA868100FCE4 Acknowledge message from this unit to remote.
<INVALID> 01FA860000800100009286 Corrupted message received.

DO1 to DO8, DIO1 to DIO12

These options allow the user to set and clear digital outputs. To set an output, select the corresponding menu item, at the prompt, type the value FFFF to turn the output ON, or 0000 to turn the output OFF. For example, to set DO1 ON,

>e

DO1

>FFFF

AO1 to AO8

These options allow the user to set analog outputs to any value. To set the output, select the corresponding menu item. At the prompt type the value required for the analog output as a four digit hexadecimal value. Refer to the table above for analog current/expected value relationship. To set AO2 on WI-I/O-EX-1-13 to 19 mA :

>m

AO2

>B800

Switch

This option allows testing of the DIL (Dual In Line) switches. The diagram below indicates the layout of the switches of which there are two sets of eight, with an "Enter" button located to the right of the pair. the display indicates the current switch settings with the digit '1' corresponding to 'On' and the digit '0' corresponding to 'Off'. Changing the switch settings in this mode will change the display. Test each switch and check to ensure the display changes accordingly.

Switches

1	1	1	0	0	0	1	0
---	---	---	---	---	---	---	---

0	1	0	1	0	1	0	1
---	---	---	---	---	---	---	---

Displayed

1110001001010101

Signal

This option provides for testing the radio path between two units for a suitable reliability margin. Although a pair of units may communicate successfully, radio communication may be affected by a range of influences, including atmospheric conditions, changing landscape, degradation of antennas or co-axial cable, low battery voltage etc. “Fade margin” is an indication of how far a radio path can deteriorate before communication becomes unreliable.

When using the Signal feature, the current received radio signal level is displayed in negative dBm (dBm is relative to 1mW of RF power). A display of 100 means –100dBm. This means that a stronger signal will have a lower measured value.

To check the radio path between two units, select the signal option at the local unit. The display will initially show the background noise of the radio band. Determine the approximate average of the noise level. The remote unit may then be set up for tone reversals (refer 1 above). Determine the approximate average of the received signal strength. It is normal for the measured values to continually change - the radios are continually changing frequency. Calculate the best average for both the noise and signal. For a reliable radio path, the signal strength must be at least 10dB lower than the noise level, or 98, whichever is less.

For example, if the noise level is 120, then the radio signal must be 98 or lower for a reliable path. If the noise level is 100, then the radio signal must be 90 or lower.

A simpler method when remote units are not easily accessible is to cause a transmission from the local unit to the remote unit (by setting a digital input which maps to the remote unit, for example). The meter will latch the received signal from the remote unit for half a second, allowing the received level to be read.

If any obstructions in the radio path are likely to change, then this should be allowed for. For example, if the radio test is done during winter and the radio path is through trees without leaves, then another 10dB of margin should be allowed for to cover summer conditions when the trees have leaves.

When using directional antennas (i.e. YAGI antennas) this feature may be used to peak the received signal level. Set-up the remote unit to transmit tone reversals as described above, and observe the signal indication while adjusting the orientation of the antenna. A peak in signal level indicates optimum orientation of the antenna.

6.2.4 Comms Logging

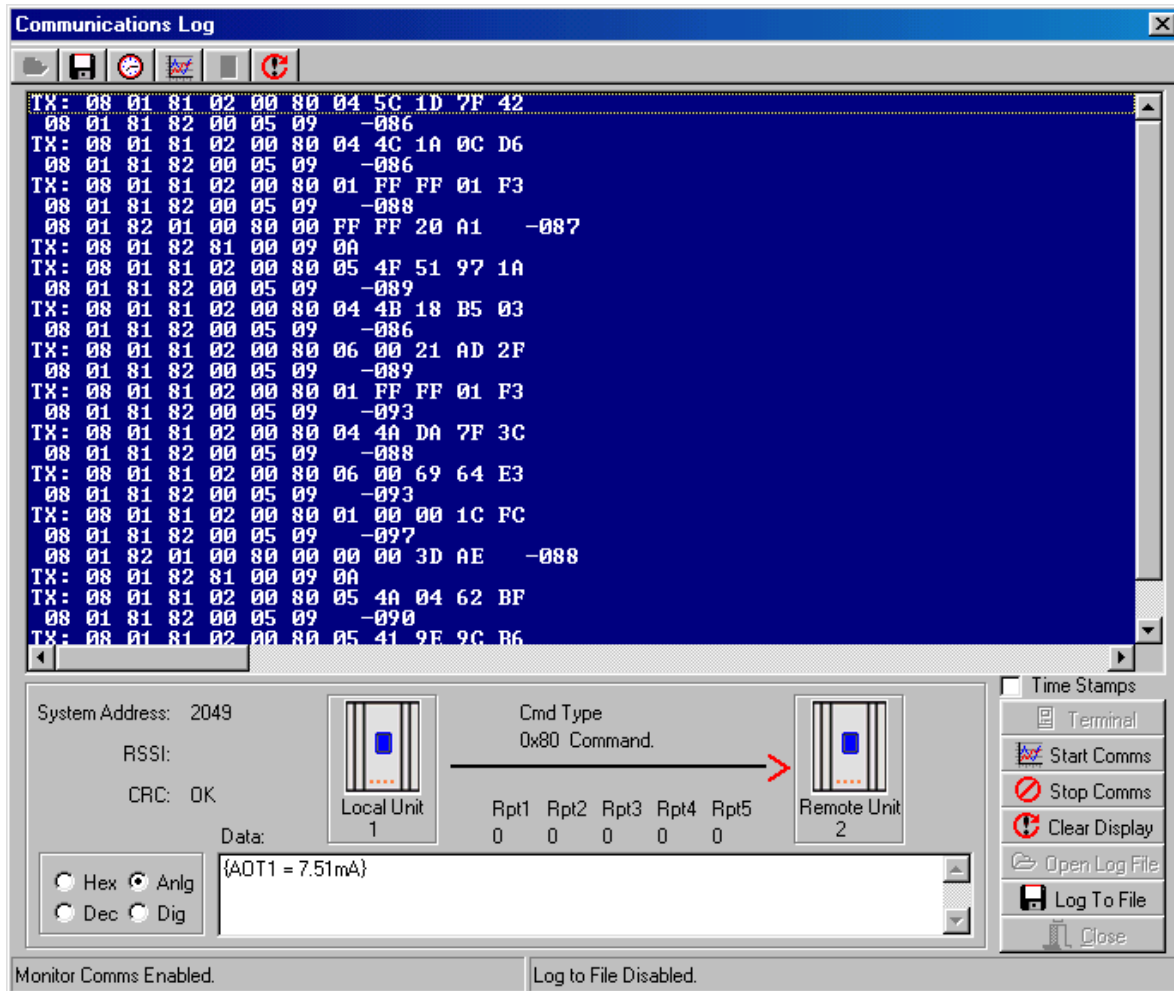

These options allow logging and display of radio communications. To start “Comms logging”:

- select option the “Comms” option from the diagnostics menu (see section 6.2.3),
- select ‘Stop Terminal’ and then
- select ‘Start Comms’.

The display will show radio messages transmitted and received. Messages starting with TX are transmitted messages, and received messages start with a small line indent. At the end of each received message is the RSSI (radio signal strength) in dBm.

If you select any message line with the mouse, information about the message will be displayed at the bottom of the screen - the system address, RSSI and CRC (error-check) status. The “text box” at the bottom middle of the screen decodes the message - that is, it decodes the message to display I/O channel and value.

You can display the register values in Decimal by selecting “Dec” at the bottom of the screen. If you select “Dig”, the values will be displayed as a 0 or 1 digital value (1 if the 16-bit value is greater than 50% - that is, the most significant bit is 1). If you select “Anlg”, the value will be displayed as a 4-20mA range.

To stop “comms logging”, select the “Stop Comms” box. You can then shut down the diagnostics

screen, or select “Terminal” to go back to the diagnostics menu.

Add Time Stamps

Time stamps can be added by selecting the “Time Stamps” box. This will allow the current time and date to be displayed with each message. The “Comms log” can be saved to a file for future reference by selecting “Log to File”.

6.3

Radio Path Testing

To carry out a radio path test, you will need two WI-I/O 9-x modules. One module will be “fixed” and the other “mobile”. Both units will need power supplies and antennas. The power supply for the mobile unit is normally a 12V battery, but make sure that the battery is fully charged - batteries with low voltage will lead to low radio power which will affect the test result.

The object of the test is to determine whether radio paths are reliable, marginal or unreliable. A reliable path will have a margin of at least 10dB above the background noise level in good weather - this margin is enough to ensure that the radio path remains reliable in poor conditions. A marginal path will work reliably in good conditions, however will fail during poor conditions. If the test is carried out during rainy or foggy weather, then a margin of only 5dB is required.

Procedure:

- ❑ Configure the modules to the same system address, and on each module, configure DI1 to DO1 on the other module. At the fixed module, wire DO1 to DI1 such that DI1 will turn ON when DO1 turns ON. Connect a switch to DI1 on the mobile unit.
- ❑ When the modules are close to each other, test the system - close the switch, forcing the mobile unit to transmit. The mobile unit will transmit to the fixed unit, and the fixed unit will transmit back to the mobile unit, activating DO1. Turning off the switch will result in two radio transmissions, turning off DO1. Each time the switch is changed, there should be two radio messages (two sets of TX/RX flashes) at the mobile unit. Note that when the modules are within a couple of metres, they may not work well with antennas connected - in this case, test without antennas.
- ❑ Set up the fixed module in one of the test positions - this is normally at a control centre or repeater site. Fix the antenna in a temporary fashion. You will need to make an initial assessment on how high the antenna should be mounted.
- ❑ Take the mobile module to the other end of the radio path. The antenna at this end can be either held by the tester, or fixed in a temporary fashion. Note that a person’s body will affect the radiation pattern of an antenna, so if the antenna is hand-held and the test is not successful, try again with the antenna fixed to a 1 metre length of plastic pipe or timber. The tester holds the length of pipe or timber with the antenna above head height.
- ❑ Test the radio path by operating the switch. If the radio path is short, and there is a high level of confidence that the radio path will be reliable, the result can be checked by simply looking at the TX/RX leds on the mobile unit. If each TX flash is followed immediately by a RX flash (that is,

the TX flash does not flash twice or more times before the RX flashes), then the radio path is likely to be reliable. Operate the switch several times - do not rely on one test. If the test is being done outside, the leds will need to be shaded to view the flashes.

- If the radio path is uncertain, then the result should be measured by connecting a laptop computer, following the procedure outlined in this manual for measuring the radio signal strength. Before the switch is operated, the background noise level should be measured and recorded. This measurement is likely to “jump around” or oscillate, to determine an average measurement. Now operate the switch several times - take the average measurement of the signal transmitted from the fixed unit.
- The radio path is reliable if the transmitted signal is 10dB above the noise level, or better than –98dBm. For example, if the noise level is –115dBm, then the minimum level for reliability is –98dBm. If the noise level is –100dBm, then you need –90dBm for a reliable path. If the laptop displays a scale measurement instead of a numerical measurement, then the transmitted signal should be at least 3 divisions, and at least 2 divisions above the noise level.
- If the weather is poor during the test, then the transmitted signal needs to be 5dB above noise, or 1 division. It is best not to do radio tests during poor weather.
- Record these measurements for comparison later during commissioning or if the system has problems later.

If the radio path test is not successful:

1. Increasing the height of the antenna at either module, or at both modules can significantly improve the result. Sometimes moving the antenna to the side helps, if there is an obvious obstruction in the radio path.
2. Change one or both antennas to a higher gain if regulations allow.
3. Use a shorter coaxial cable between the antenna and the WI-I/O 9-x.(this may involve moving WI-I/O 9-x nearer to antenna mounting), or use a different coaxial cable with lower loss.
4. If a reliable radio path is not possible because of distance or path obstructions, you will need to consider using a repeater module. The ideal repeater is another module in the system, in a good location to act as a repeater. If this is not the case, you need to consider installing a module to act specifically as a repeater.

Chapter Seven **WARRANTY & SERVICE**

We are pleased that you have purchased this product.

Weidmuller, Inc. products are warranted to be free from manufacturing defects for the “serviceable lifetime” of the product. The “serviceable lifetime” is limited to the availability of electronic components. If the serviceable life is reached in less than three years following the original purchase from Weidmuller, Inc., Weidmuller, Inc. will replace the product with an equivalent product if an equivalent product is available.

This warranty does not extend to:

- failures caused by the operation of the equipment outside the particular product's specification, or
- use of the module not in accordance with this User Manual, or
- abuse, misuse, neglect or damage by external causes, or
- repairs, alterations, or modifications undertaken other than by an authorized Service Agent.

Weidmuller, Inc.’s liability under this warranty is limited to the replacement or repair of the product. This warranty is in lieu of and exclusive of all other warranties. This warranty does not indemnify the purchaser of products for any consequential claim for damages or loss of operations or profits and Weidmuller, Inc. is not liable for any consequential damages or loss of operations or profits resulting from the use of these products. Weidmuller, Inc. is not liable for damages, losses, costs, injury or harm incurred as a consequence of any representations, warranties or conditions made by Weidmuller, Inc. or its representatives or by any other party, except as expressed solely in this document..

Full product specifications and maintenance instructions are available from your Service Agent, your source of purchase, or from the master distributor in your country upon request and should be noted if you are in any doubt about the operating environment for your equipment purchase

In the unlikely event of your purchase being faulty, your warranty extends to free repair or replacement of the faulty unit, after its receipt at the master distributor in your country. Our warranty does not include transport or insurance charges relating to a warranty claim.

Should you wish to make a warranty claim, or obtain service, please forward the module to the nearest authorised Service Agent along with proof of purchase. For details of authorised Service Agents, contact your sales distributor.

Appendix A SYSTEM EXAMPLE

The following example of a system is a comprehensive guide to using some of the features of the range and design of system.

The example application is a pump station which supplies water from a reservoir to a tank station. Signals are transferred between the pump station and tank station by radio - the distance between the two stations is 10 km (6 mile), and the radio path is heavily obstructed by buildings and trees. A control station is located near the pump station, and there is an existing signal cable between the control station and the pump station.

A WI-I/O 9-1 module is installed at the pump station (with address 1) and a WI-I/O 9-2 module is installed at the tank station (with address 2). Because the signal cable to the control station does not have enough cores for all of the signals required, the signal cable is used as a RS485 cable and a WI-I/O-EX-1-S-x-3 module is installed at the control station (with address 96). As this module has an address greater than 95, the WI-I/O 9-1 at the pump station will communicate to it via its serial port.

The following diagram represents the system:-

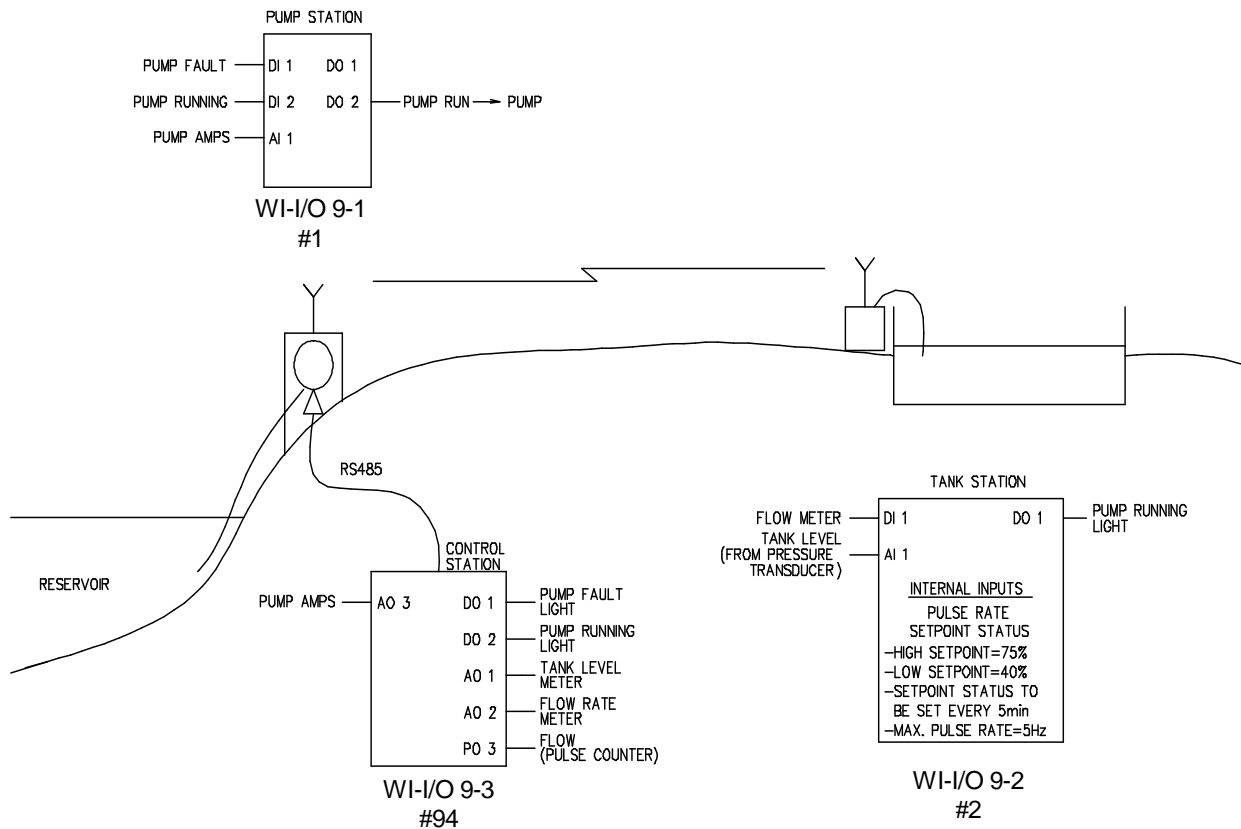

The following design points should be noted :-

- A test of the radio path between the pump station and the tank station indicated that the radio path would be reliable provided antennas were installed at 6 m above the ground. At each site, the coaxial cable would be approx 30 feet in length, so it was decided to use 6 element Yagi antennas with RG58 coaxial cable - the Yagi antennas would compensate for the loss in the cable.
- At the tank station, there was an existing light pole with a mains power supply - the light pole was 10m high. Permission was obtained to mount the antenna from the pole and to use the power supply for the radio telemetry module.

As there was no existing electrical panel at this station, a small steel enclosure was installed on the light pole. A 2 Amp-Hour sealed battery was installed to provide power during any mains failure. The flow and level transducer were powered from the 24VDC loop supply provided by the module.

- At the pump station, the antenna was mounted on a 10' J-bracket installed on the roof of the pump station building. The final height of the antenna was approx 20 feet. Care was taken to align the Yagi antennas so they pointed at each other. The Yagi antennas were installed with horizontal polarity - that is, with the elements horizontal. These antennas will not "hear" other radio users on the same radio channel which generally use vertical polarity.

There was an existing electrical enclosure at the pump station, and the WI-I/O 9-x module was installed inside this enclosure. The module was powered from a 24VDC supply with a 2 Amp Hour sealed battery as backup.

- At the control station, the WI-I/O-EX-1-S-x module was installed inside the existing control panel enclosure. The module was powered from an existing 24VDC power supply.

Tank Station Configuration

The WI-I/O 9-2 module has the following configuration :-

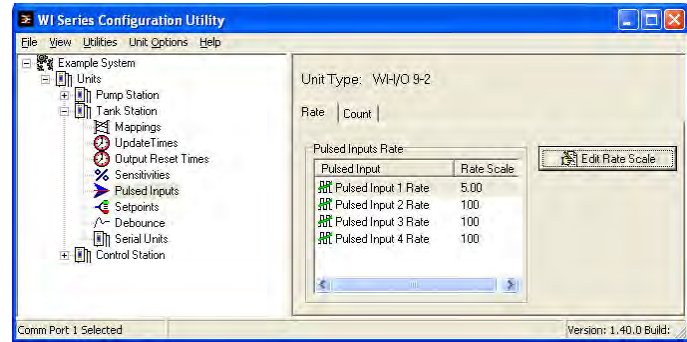
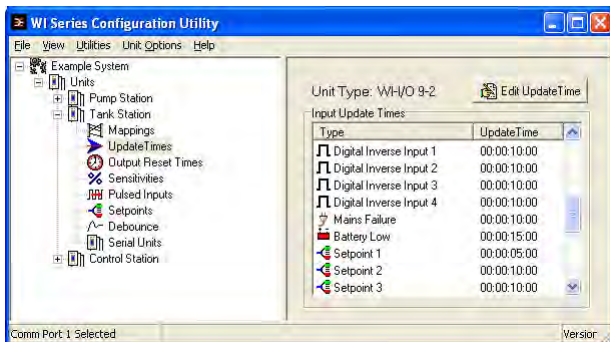
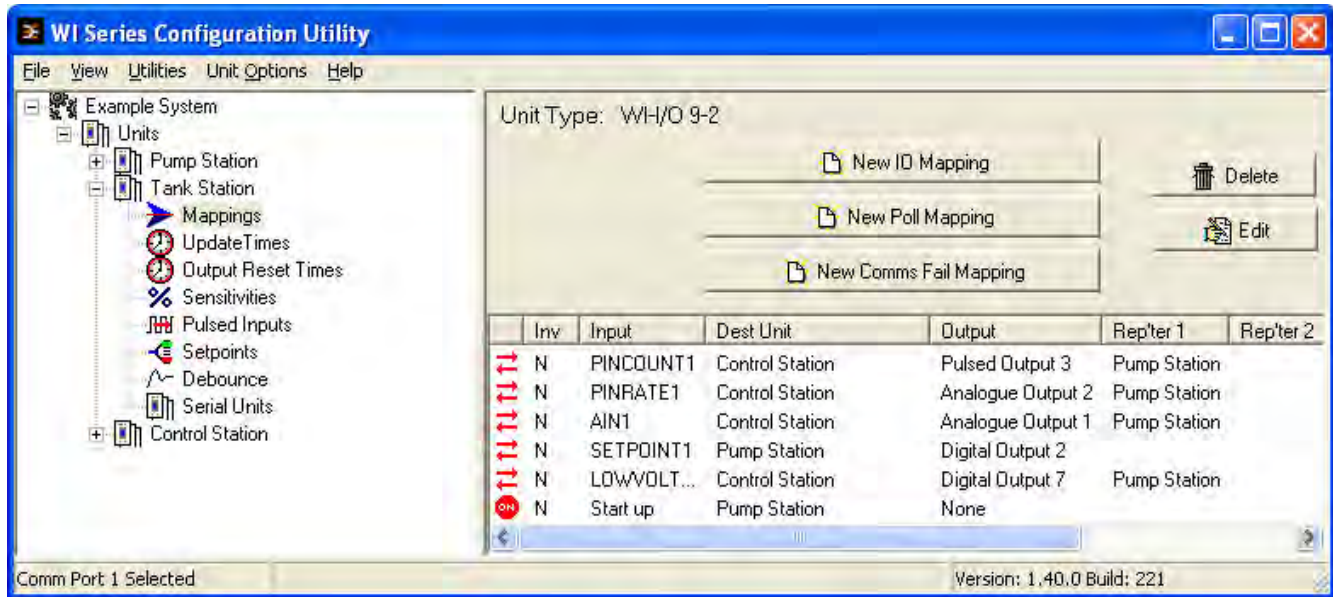

Note the following points in the configuration:

- #1 is a repeater for communications between #2 and #94
- The pulse rate scaling for PIN1 has been set to 5 Hz to match the maximum flow rate of the flow meter. Note that PIN1 has not been configured for "divide by 10" (for 1000 Hz pulse signals).
- AIN1 (the level transducer) is mapped to AO1 at the WI-I/O 9-3. The analog debounce has been set to 2 sec. This is because of concern of wave action on the surface of the tank causing un-necessary change transmissions. This debounce time will also operate on the Pulse Rate value, but as the flow rate changes slowly, this will not affect the

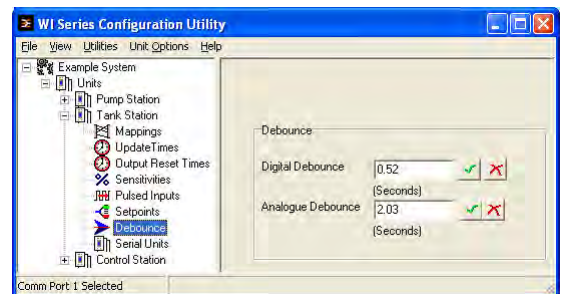

performance of this signal.

- SETPOINT1 (the set-point status for AI1) is mapped to DO2 of #1 (pump station). The set-point values for this setpoint have been set to 40% and 75%. When the tank level drops to 40%, DO2 at the pump station will activate to start the pump. When the level rises above 75%, DO2 will reset to stop the pump.
- The update time for SETPOINT1 has been changed to 5 minute, as required.
- An additional mapping has been entered - LOW VOLT has been mapped to DO7 at #94 via #1 (DO7 at the control station). This mapping is for future use - it will provide a low battery voltage alarm for the tank station. The update time for this mapping has been set to the maximum time of 15 minutes to reduce loading of the radio channel.
- A Start-up poll has been configured for #1, as DO1 at the tank station is controlled from the pump station. Note that no comms fail reset time has been configured for DO1. As this output drives an indication only, the indication will show the last correct status even during communication failures.

Pump Station Configuration

The WI-I/O 9-1 module has the following configuration :-

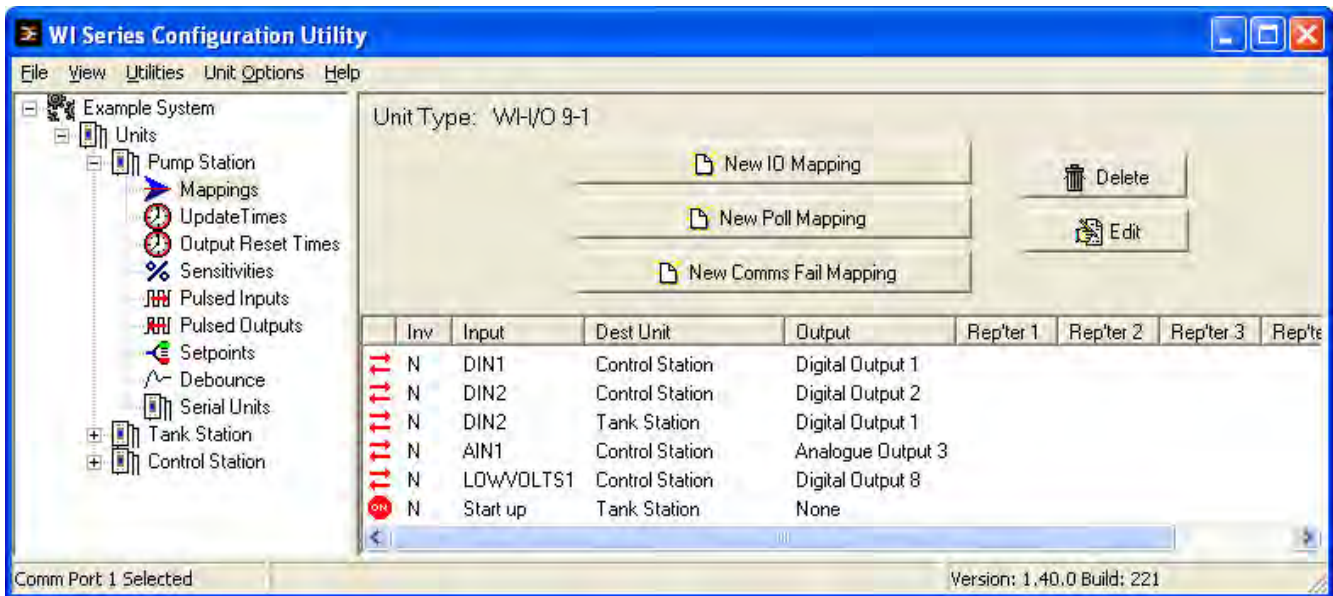

Note the following points in the configuration:

- Note that no repeater address is necessary between #1 and #94.
- DIN2 (pump running signal) has two mappings - a mapping to DO1 at #2 (tank station) and DO2 at #94 (control station). When DIN2 changes, there will be two separate change messages transmitted - one by radio to #2 and one by serial link to #96.
- AIN1 (pump amps) is mapped to AO3 at #94 (control station).

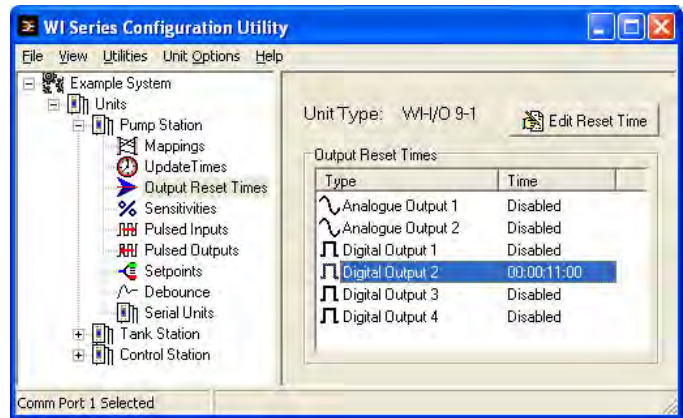

- An additional mapping has been entered - LOW VOLT has been mapped to DO8 at the control station. This mapping is for future use - it will provide a low battery voltage alarm for the pump station.
- A Start-up poll has been configured for #2, as DO2 at the pump station is controlled from the tank station. Note that a comms fail reset time of 11 minutes has been configured for DO2. This means that if a message has not been received for DO2 within 11 minutes, DO2 will reset and switch off the pump. The 11 min time was chosen as it means that two successive update messages have to be missed before the pump is reset, and there is no problems if the pump runs for 11 minutes during a system failure (the tank will not overflow during this time).

Control Station Configuration

The WI-I/O-EX-1-S-3 module has the following configuration :-

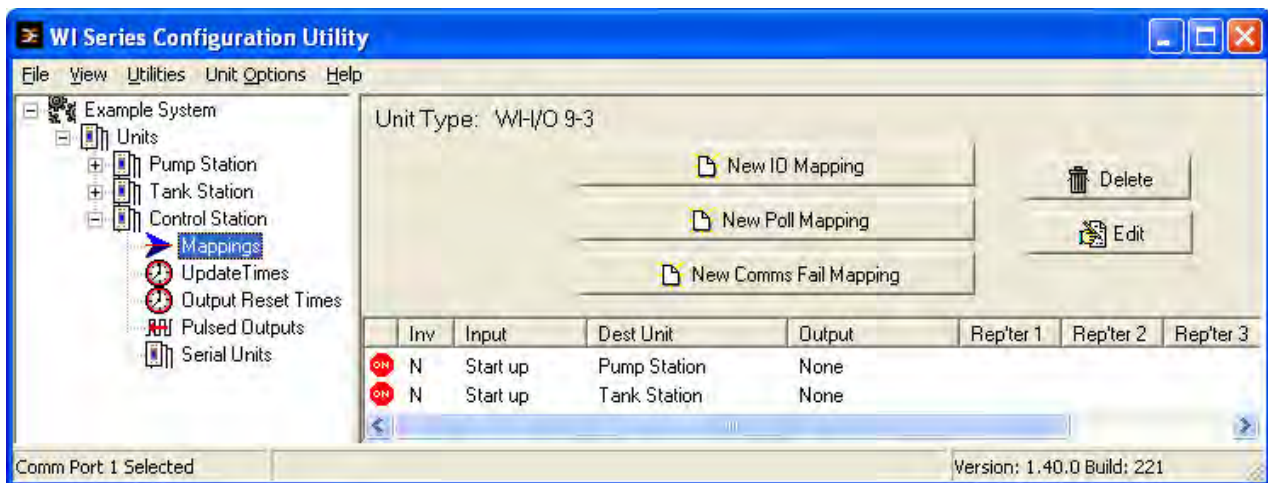

Note the following points in the configuration:

- The only mappings are Start-up polls. Note that there are two separate polls, one for each remote module.
- PO 3 has been configured as a PO. Its pulse output update time is the same as the PI update time at the remote module (both have been left at their default value of 1 minute).
- Reset times have been selected for the analog outputs (21 minutes) but not the digital outputs. In the event of a system failure, the digital outputs will stay at their last correct status, but the analog outputs will reset to 0 mA.

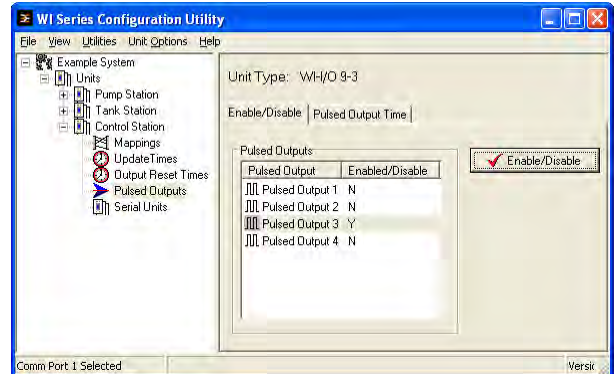

System Failure Alarm

After the system had been running for some time, the operators wanted a "system failure" output at the control station, to warn the operators that there was a fault with the system.

The following configuration was added :

At #2 (tank station), Inverse DI4 → DO4 at #94 via 1 ; DI4 Update time = 1 minute

At #94 (control station), DO4 Comms fail reset time = 3.5 min

At the control station, DO4 was a "system OK" signal. It was normally active - if the signal reset, then this represented a system failure. At the tank station, there is no signal wired to DI4. By mapping Inv DI4 to DO4 at the control station, a message is transmitted every minute to this output to activate it. The message is transmitted via the radio link to #1, and then by the serial link to #94. If anything happened to either module #2 or module #1, or the radio link, or the serial link, then the update messages for DO4 will not be received at the control station module. After 3.5 Minutes, DO4 will reset indicating a problem.

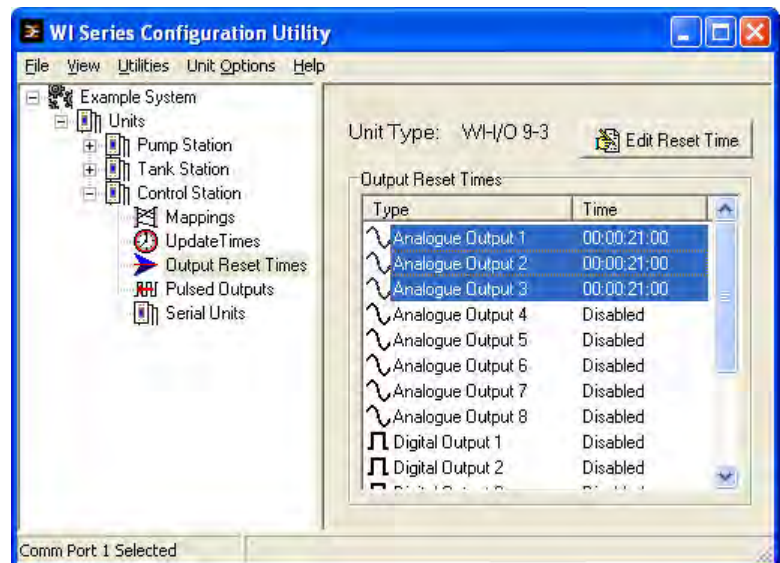

The time of 3.5 minutes was selected as this means that 3 successive update messages have to be missed before a system alarm occurs. Also note, that if module #94 fails, DO4 will reset and give an alarm signal.

Appendix B

TERMINAL LAYOUTS

WIRING DRAWING -WI-I/O 9-1 WI-I/O-EX-1-S-1

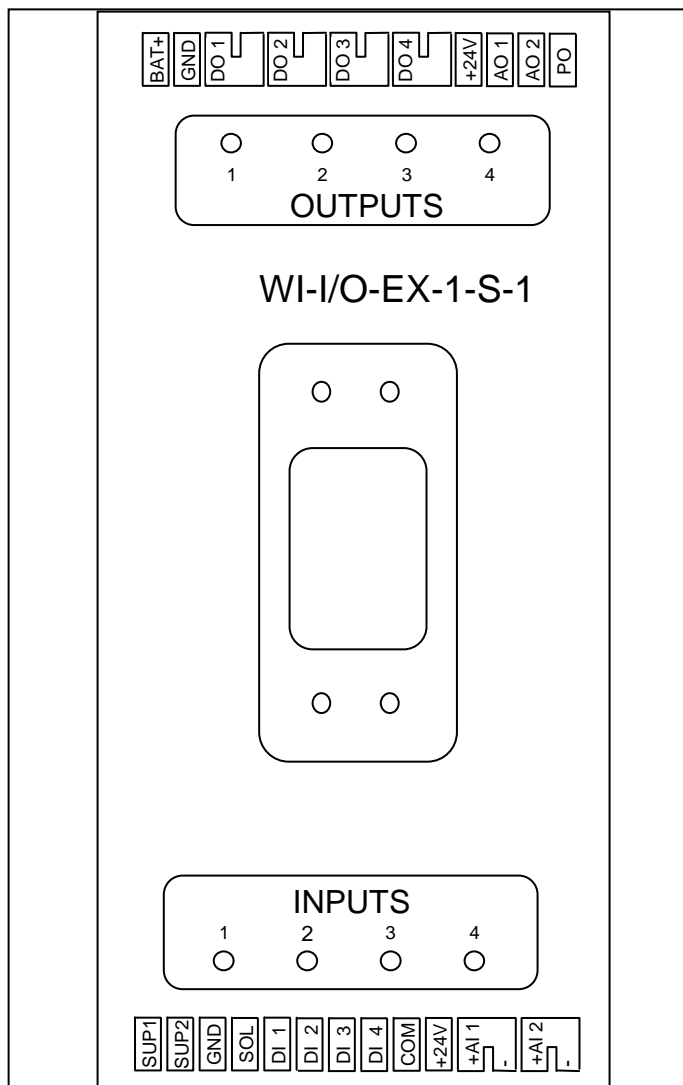

WIRING DRAWING - WI-I/O 9-2 WI-I/O-EX-1-S-2

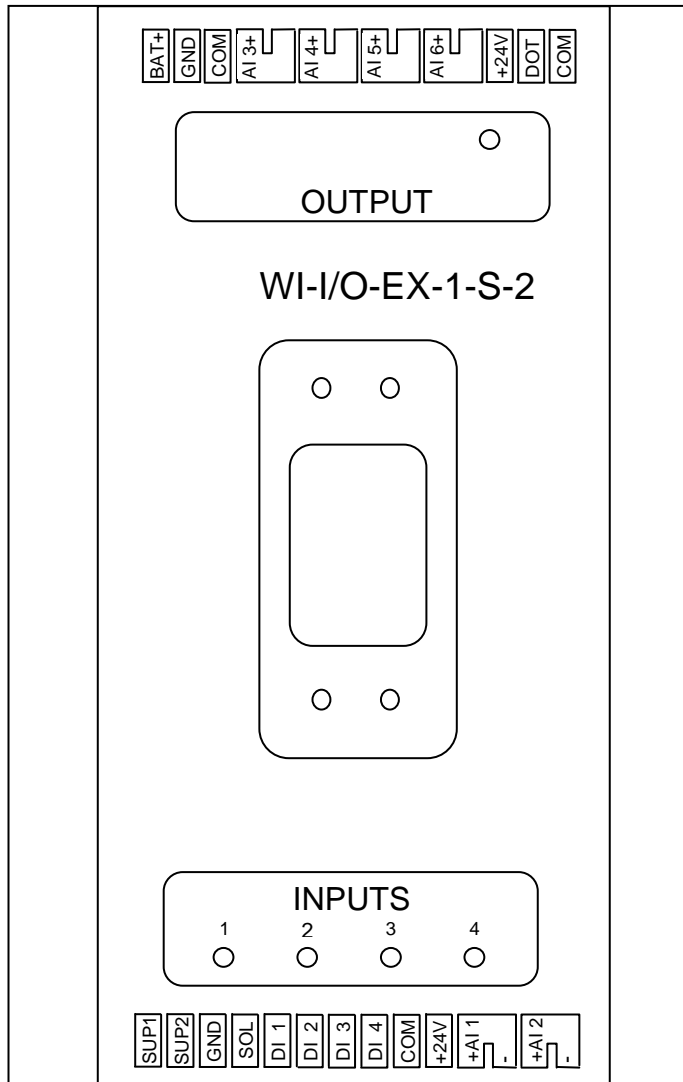

WIRING DRAWING - WI-I/O 9-3, WI-I/O-EX-1-S-3

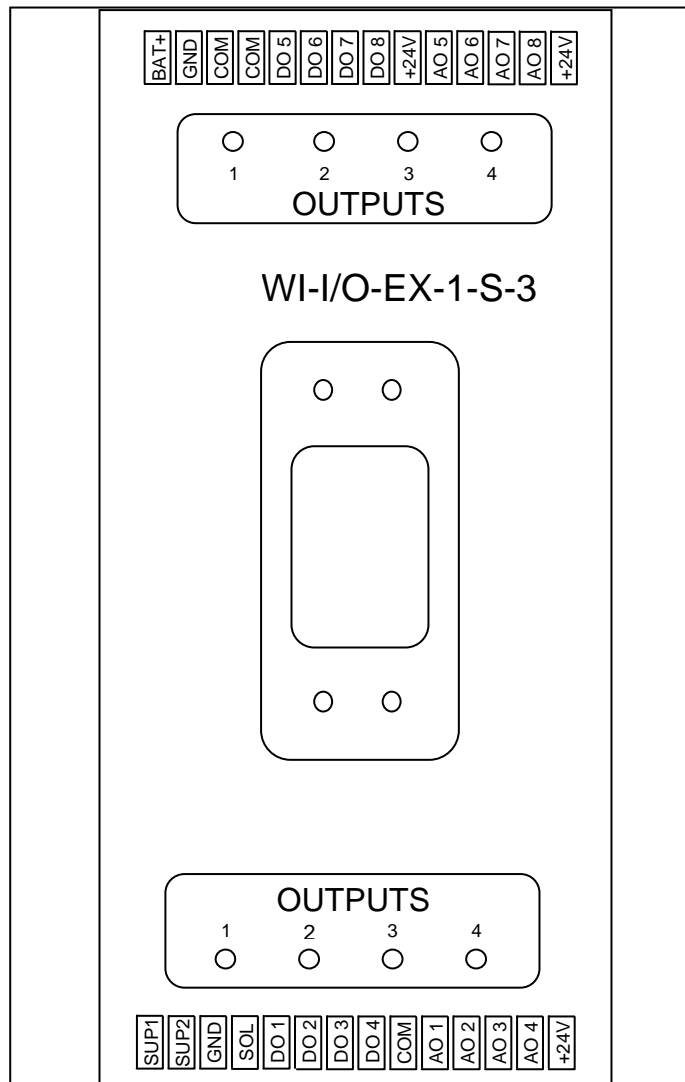

WIRING DRAWING -WI-I/O 9-4, WI-I/O-EX-1-S-4

